

## DC-to-DC Step-Down Converter

### Features and Benefits

- 1.5 A output current supplied in a small, through-hole mount power package
- High efficiency: 81% at  $V_{IN}=15\text{ V}$ ,  $I_O=0.5\text{ A}$ ,  $V_O=5\text{ V}$
- Requires only six external components (optional soft start requires an additional capacitor)
- Oscillation circuit built-in (frequency 300 kHz typical)
- Constant-current mode overcurrent protection circuit and overtemperature protection circuit built-in
- Soft start function built-in (can be implemented as an on/off function; output-off state at low level)
- Low current consumption during output-off state

### Package: TO220F-5

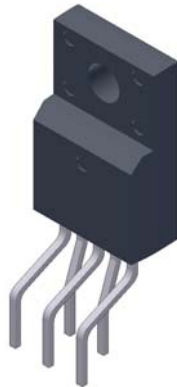

Not to scale

### Description

The SI-8008TFE DC voltage regulator is a DC-to-DC buck convertor that attains an oscillation frequency of 300 kHz, and has an integrated miniaturized choke coil, allowing it to serve as a small, high efficiency power supply in a compact TO220F package.

The internal switching regulator function provides high efficiency switching regulation without any need for adjustment. The device requires only six external support components. The optional soft start function requires an additional capacitor. Optional on/off control can be performed using a transistor. The SI-8008TFE includes overcurrent and overtemperature protection circuits.

Applications include:

- DVD recorder
- FPD TV
- Telecommunications equipment
- Office automation equipment, such as printers
- On-board local power supply
- Output voltage regulator for second stage of SMPS (switched mode power supply)

### Functional Block Diagram

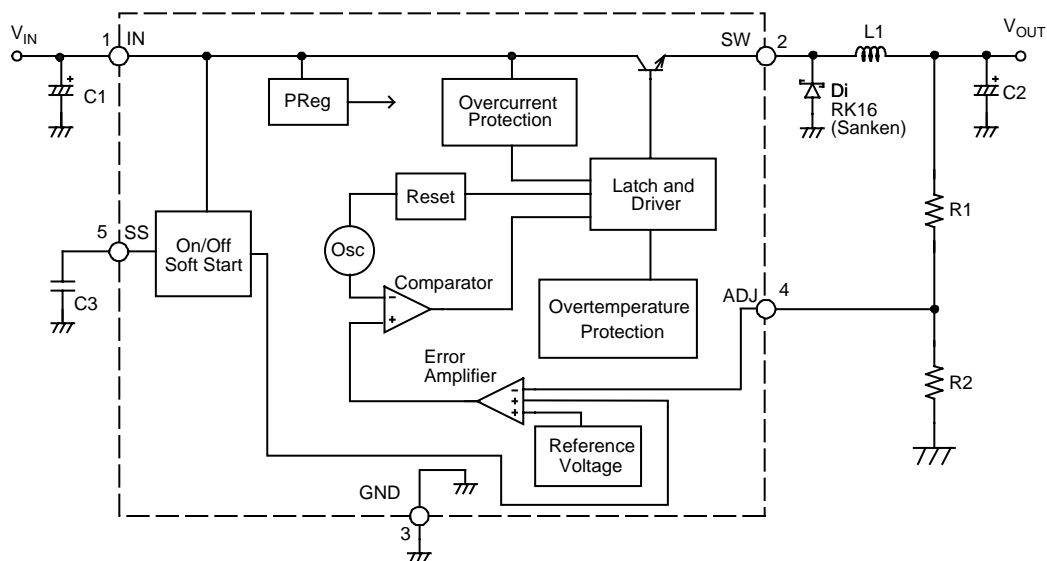

## Selection Guide

Part Number	Output Voltage Adjustable Range (V)	Efficiency, Typ. (%)	Input Voltage, Max. (V)	Output Current, Max. (A)	Packing
SI-8008TFE	0.8 to 24	81	40	1.5	50 pieces per tube

## Absolute Maximum Ratings

Characteristic	Symbol	Remarks	Rating	Units
DC Input Voltage	$V_{IN}$		43	V
Power Dissipation	$P_{D1-1}$	Connected to infinite heatsink; $T_J(\text{max}) = 150^\circ\text{C}$ , limited by internal overtemperature protection.	17.8	W
	$P_{D1-2}$	Connected to infinite heatsink; $T_J = 125^\circ\text{C}$ .	14.2	W
	$P_{D2-1}$	No heatsink; $T_J(\text{max}) = 150^\circ\text{C}$ , limited by internal overtemperature protection.	2.15	W
	$P_{D2-2}$	No heatsink; $T_J = 125^\circ\text{C}$ .	1.72	W
Junction Temperature	$T_J$	Internal overtemperature protection circuit may enable when $T_J \geq 130^\circ\text{C}$ . During product operation, recommended $T_J \leq 125^\circ\text{C}$ .	-30 to 150	$^\circ\text{C}$
Storage Temperature	$T_{stg}$		-40 to 150	$^\circ\text{C}$
Thermal Resistance (junction-to-case)	$R_{\theta JC}$		7	$^\circ\text{C}/\text{W}$
Thermal Resistance (junction-to-ambient air)	$R_{\theta JA}$		58	$^\circ\text{C}/\text{W}$

## Recommended Operating Conditions\*

Characteristic	Symbol	Remarks	Min.	Max.	Units
DC Input Voltage Range	$V_{IN}$	$V_{IN}(\text{min})$ is the greater of 4.5 V or $V_O + 3\text{ V}$ ; $0\text{ A} \leq I_O \leq 1.5\text{ A}$ ; for $V_{IN}$ in the range $V_O + 2\text{ V}$ to $V_O + 3\text{ V}$ , $I_O \leq 1\text{ A}$ .	See remarks	40	V
DC Output Voltage Range	$V_O$		0.8	24	V
DC Output Current Range	$I_O$	$V_{IN} \geq V_O + 3\text{ V}$ ; to be used within the allowable package power dissipation characteristics (refer to Power Dissipation chart).	0	1.5	A
Operating Junction Temperature Range	$T_{JOP}$		-20	125	$^\circ\text{C}$
Operating Temperature Range	$T_{OP}$	To be used within the allowable package power dissipation characteristics (refer to Power Dissipation chart).	-20	85	$^\circ\text{C}$

\*Required for normal device functioning according to Electrical Characteristics table.

All performance characteristics given are typical values for circuit or system baseline design only and are at the nominal operating voltage and an ambient temperature,  $T_A$ , of  $25^\circ\text{C}$ , unless otherwise stated.

### ELECTRICAL CHARACTERISTICS<sup>1</sup>, valid at T<sub>A</sub> = 25°C, V<sub>O</sub> = 5 V (adjusted), R<sub>1</sub> = 4.2 kΩ, R<sub>1</sub> = 0.8 kΩ

Characteristic	Symbol	Test Conditions	Min.	Typ.	Max.	Units
Reference Voltage	V <sub>ADJ</sub>	V <sub>IN</sub> = 15 V, I <sub>O</sub> = 0.1 A	0.784	0.800	0.816	V
Reference Voltage Temperature Coefficient	ΔV <sub>ADJ</sub> /ΔT	V <sub>IN</sub> = 15 V, I <sub>O</sub> = 0.1 A, T <sub>C</sub> = 0 to 100 °C	–	±0.1	–	mV/°C
Efficiency <sup>2</sup>	η	V <sub>IN</sub> = 15 V, I <sub>O</sub> = 0.5 A	–	81	–	%
Operating Frequency	f <sub>O</sub>	V <sub>IN</sub> = 15 V, I <sub>O</sub> = 0.5 A	–	300	–	kHz
Line Regulation	V <sub>Line</sub>	V <sub>IN</sub> = 10 to 30 V, I <sub>O</sub> = 0.5 A	–	60	80	mV
Load Regulation	V <sub>Load</sub>	V <sub>IN</sub> = 15 V, I <sub>O</sub> = 0.2 to 1.5 A	–	10	40	mV
Overcurrent Protection Threshold Current	I <sub>S</sub>	V <sub>IN</sub> = 15 V	1.6	–	–	A
SS Terminal On/Off Operation Threshold Voltage	V <sub>SSL</sub>		–	–	0.5	V
SS Terminal On/Off Operation Outflow Current	I <sub>SSL</sub>	V <sub>SSL</sub> = 0 V	–	10	40	μA
Quiescent Current 1	I <sub>q</sub>	V <sub>IN</sub> = 15 V, I <sub>O</sub> = 0 A	–	6	–	mA
Quiescent Current 2	I <sub>q(off)</sub>	V <sub>IN</sub> = 15 V, V <sub>SS</sub> = 0 V	–	200	400	μA

<sup>1</sup>Using circuit shown in Typical Application Circuit diagram.

<sup>2</sup>Efficiency is calculated as: η(%) = (V<sub>O</sub> × I<sub>O</sub>) / (V<sub>IN</sub> × I<sub>IN</sub>) × 100.

### Pin-out Diagram

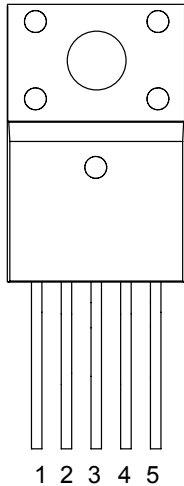

### Terminal List Table

Name	Number	Function
IN	1	Supply voltage
SW	2	Regulated supply output
GND	3	Ground terminal
ADJ	4	Terminal for resistor bridge feedback
SS	5	<p>The SS terminal is used to enable soft start and to control on/off operation of the IC output, V<sub>O</sub> (see figure 2). If neither soft start nor on/off control is used, leave pin open.</p> <p>To enable soft start, connect a capacitor between SS and ground. To control on/off operation, connect an NPN bipolar transistor, in a TTL open collector output configuration, between the SS terminal and GND. Turn off is done by decreasing V<sub>SSL</sub> below its rated level.</p> <p>When both soft start and V<sub>O</sub> on/off are used, a protection measure such as current limiting is required because, if the capacitance of C3 large, the discharge current of C3 flows across the transistor for on/off operation. Because a pull-up type resistor is provided inside the IC, no external voltage can be applied.</p>

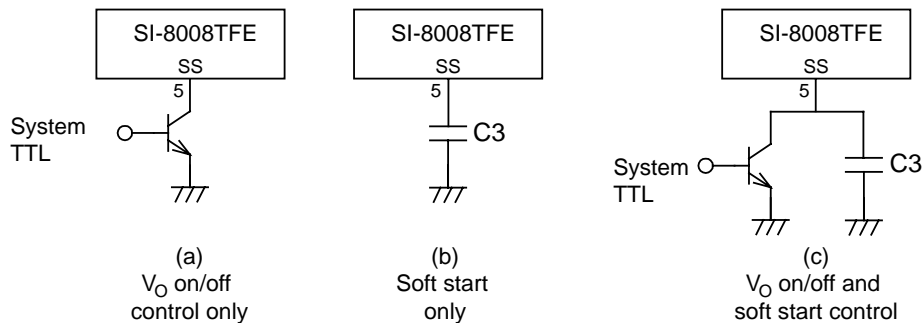
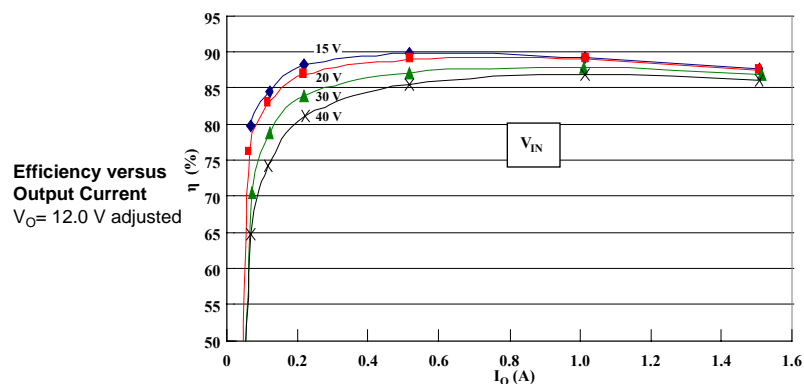
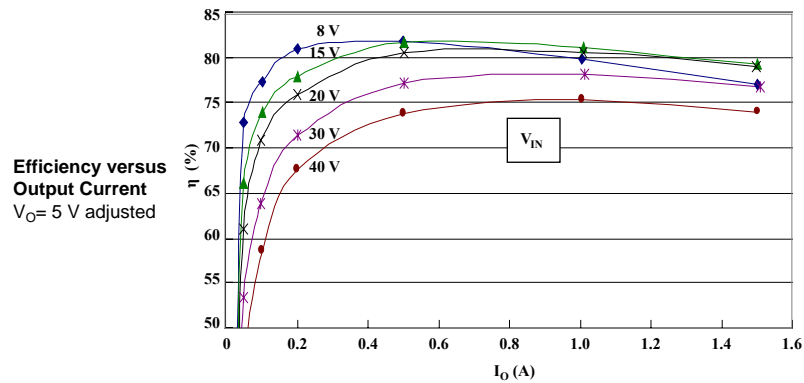
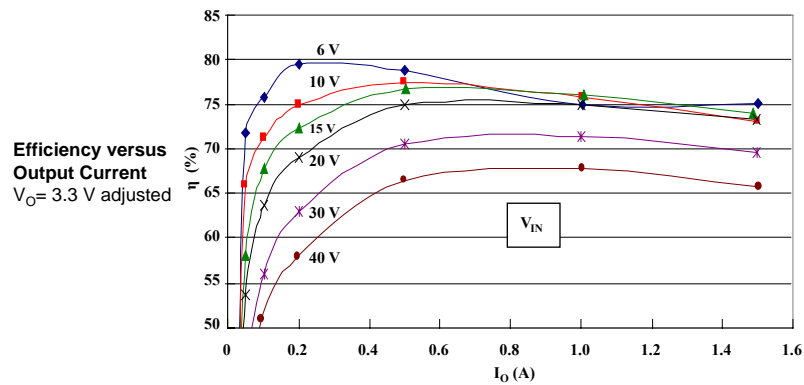
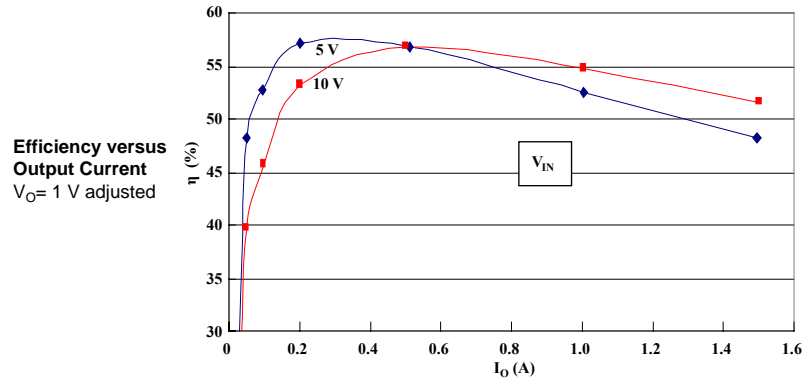

Figure 2. Alternative configurations for SS pin. If neither soft start nor V<sub>O</sub> on/off is required, the SS pin is left open.

Performance Characteristics  
at  $T_A = 25^\circ\text{C}$



Performance Characteristics

At  $T_A = 25^\circ\text{C}$ ,  $V_O = 5\text{ V}$  Adjusted,  $R_1 = 4.2\text{ k}\Omega$ ,  $R_2 = 0.8\text{ k}\Omega$

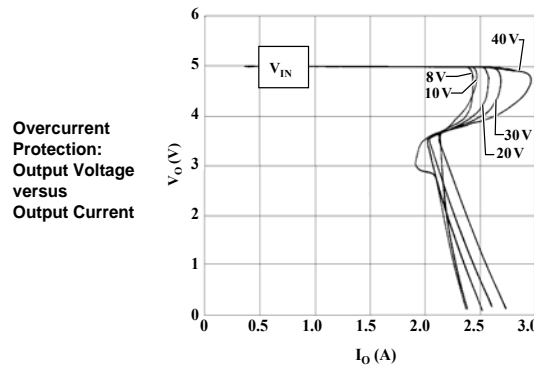
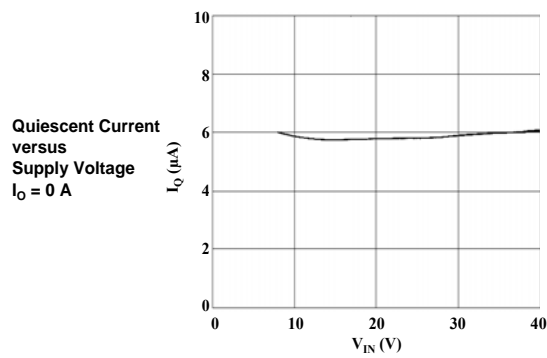
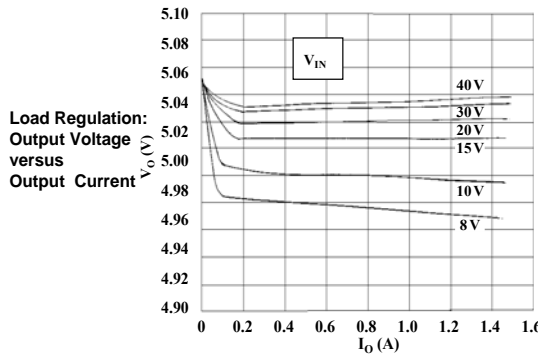
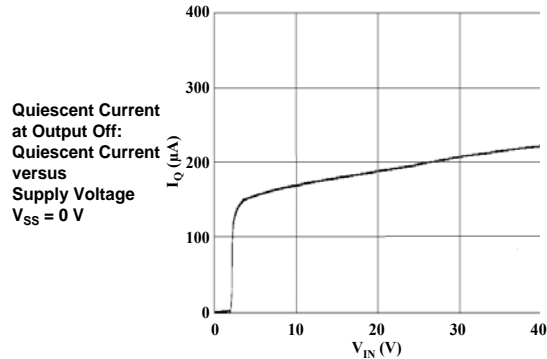
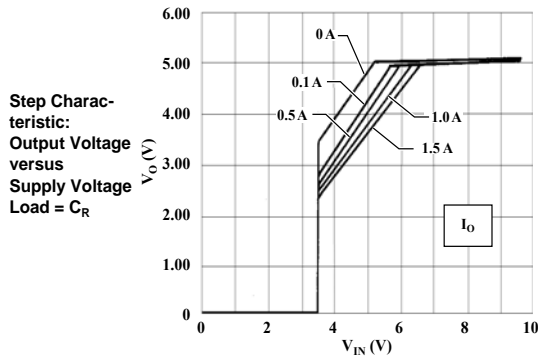

## Thermal Performance Characteristics

The application must be designed to ensure that the  $T_J(\text{max})$  of the device is not exceeded during operation. To do so, it is necessary to determine values for maximum power dissipation,  $P_D(\text{max})$ , and ambient temperature,  $T_A(\text{max})$ .

$P_D$  can be calculated from input values:

$$P_D = V_o \cdot I_o \left( \frac{100}{\eta_x} - 1 \right) - V_F \cdot I_o \left( 1 - \frac{V_o}{V_{IN}} \right)$$

where:

$V_o$  is output voltage in V,

$V_{IN}$  is input supply voltage in V,

$I_o$  is output current in A,

$\eta_x$  is IC efficiency in percent (varies with  $V_{IN}$  and  $I_o$ ; refer to efficiency performance curves for value), and

$V_F$  is forward voltage for the input diode, Di. In these tests, the Sanken RK16 was used, at 0.5 V and  $I_o = 1.5$  A. For application design, obtain thermal data from the datasheet for the diode.

$P_D$  is substantially affected by the heat conductance properties of the application, in particular any heatsink connected to the device radiation fin. The relationships of  $P_D$ ,  $T_A$ , and heatsink type is represented in the Power Dissipation chart.

Because the heat dissipation capacity of the heatsink depends substantially on how it is used in the actual application, thermal characteristics of the application must be confirmed by testing.

The internal overtemperature protection circuit may enable when  $T_J \geq 130^\circ\text{C}$ .

**Power Dissipation versus Ambient Temperature**  
Shin Etsu G746 silicon grease

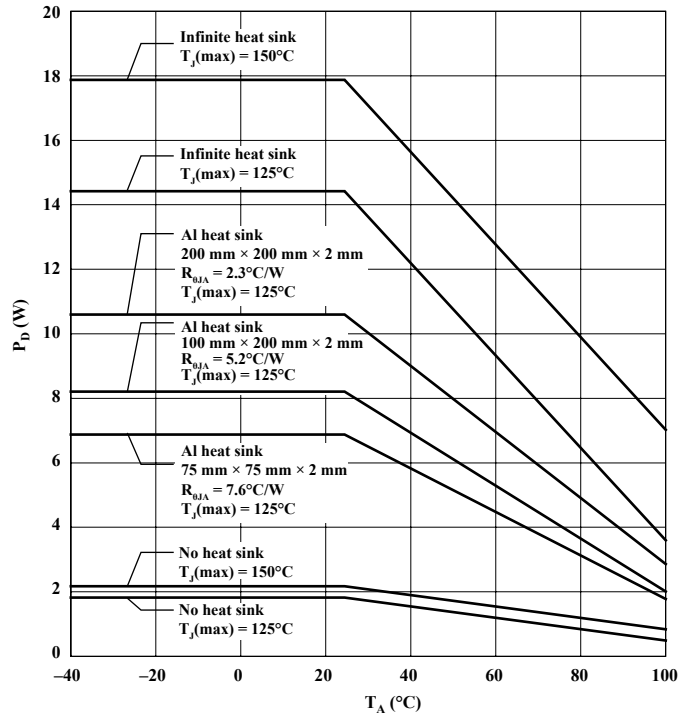

**Overtemperature Protection: Output Voltage versus Junction Temperature**  
 $V_{IN} = 8$  V,  $I_o = 0.01$  mA

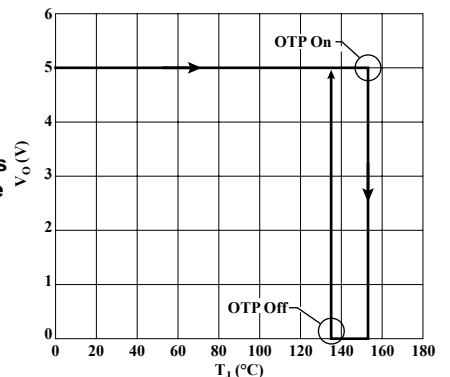

## Component Selection

**Diode Di** A Schottky-barrier diode must be used for Di. If other diode types are used, such as fast recovery diodes, the IC may be destroyed because of the reverse voltage applied by the recovery voltage or ON voltage.

**Choke Coil L1** If the winding resistance of the choke coil is too high, the efficiency may be reduced below rating. Because the overcurrent protection start current is approximately 2.5 A, attention must be paid to the heating of the choke coil by magnetic saturation due to overload or short-circuited load.

**Capacitors C1, C2, and C3** Because for SMPS, large ripple currents flow across C1 and C2, capacitors with high frequency and low impedance must be used. If the impedance of C2 is too high, the switching waveform may not be normal at low temperatures. Do not use either OS or tantalum types of capacitors for

C2, because those cause an abnormal oscillation.

C3 is required only if the soft start function is used. If not using soft-start, leave the SS terminal open. A pull-up resistor is provided inside the IC.

**Resistor Bridge R1 and R2** R1 and R2 comprise the resistor bridge for the output voltage,  $V_O$ , and are calculated as follows:

$$R1 = \frac{(V_O - V_{ADJ})}{I_{ADJ}} = \frac{(V_O - 0.8)}{1 \times 10^{-3}} (\Omega), \text{ and } R2 = \frac{V_{ADJ}}{I_{ADJ}} = \frac{0.8}{1 \times 10^{-3}} = 0.8 (\text{k}\Omega)$$

$I_{ADJ}$  should always be set to 1 mA. Note that R2 should always be present to ensure stable operation, even if  $V_O$  is set to 0.8 V (that is, even if there is no R1).  $V_O$  should be at least  $V_{IN} + 8\%$ .

## Typical Application Diagram

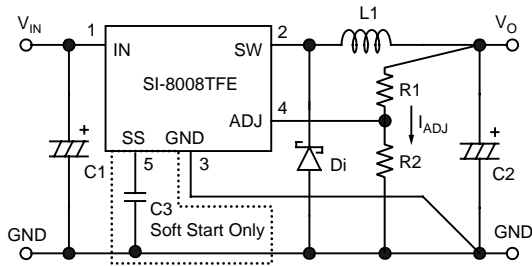

Component	Rating
C1	220 $\mu\text{F}$
C2	470 $\mu\text{F}$
C3	0.1 $\mu\text{F}$ (For soft start function)
Di	RK16 (Sanken)
L1	See chart at right

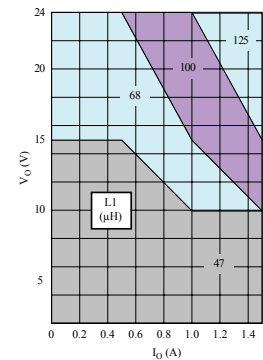

## Recommended PCB Layout

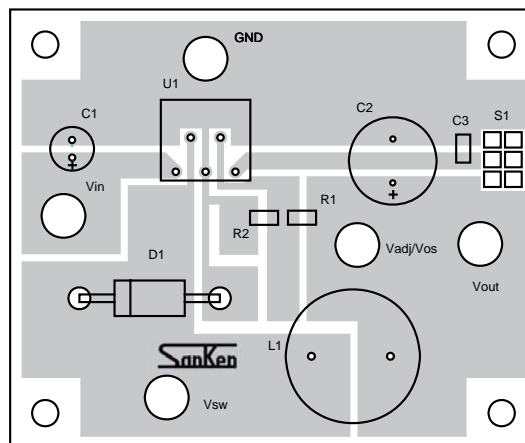

All external components should be mounted as close as possible to the SI-8008TFE. The ground of all components should be connected at one point.

## PACKAGE OUTLINE DRAWING

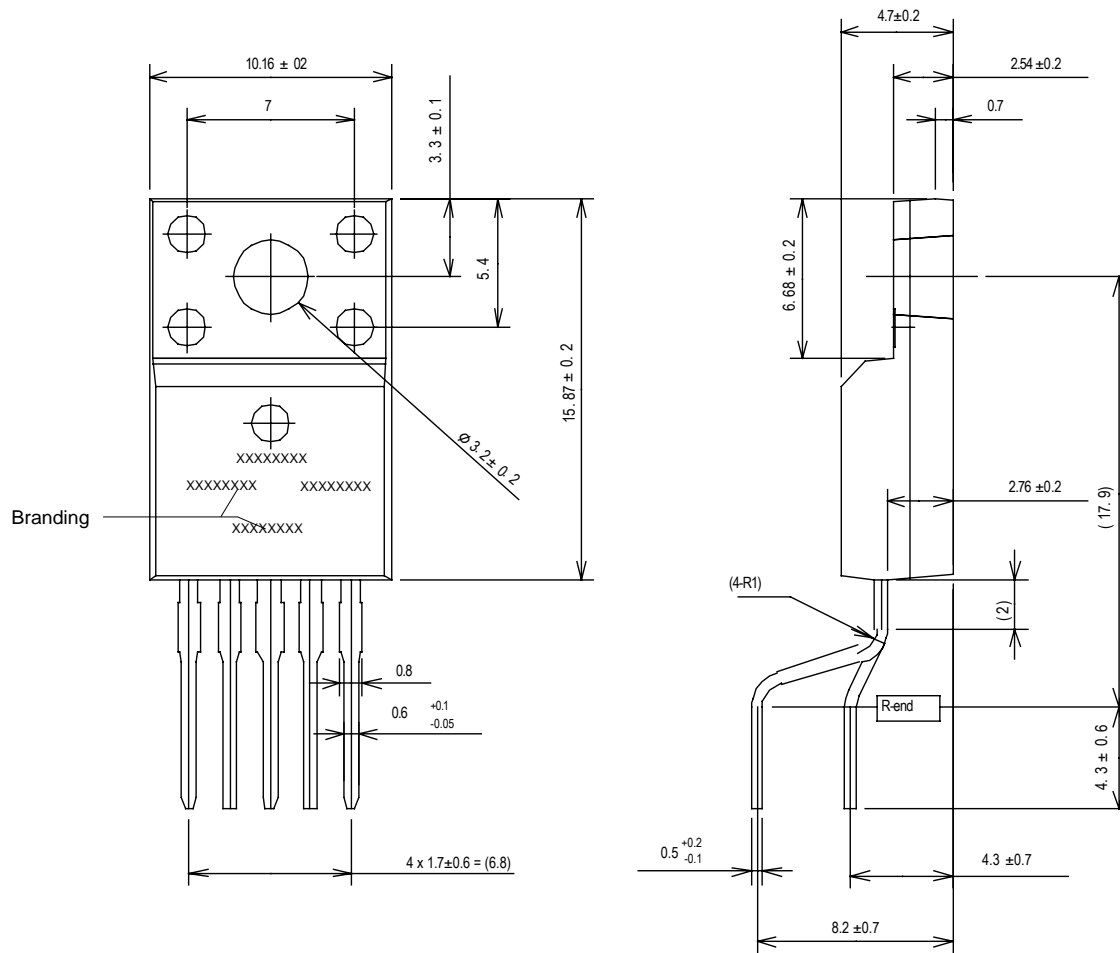

Branding codes (exact appearance at manufacturer discretion):

Leadform: 1113A  
Weight: 2.3 g typical

Dimensions in millimeters

1st line, type: 8008TFE  
2nd line, lot: SK YMW  
Where: Y is the last digit of the year of manufacture  
M is the month (1 to 9, O, N, D)  
W is the week of the month (1 to 5)  
3rd line, tracking number: nnnn



RoHS directive compliant  
Device pins lead (Pb) free

## PACKING SPECIFICATION

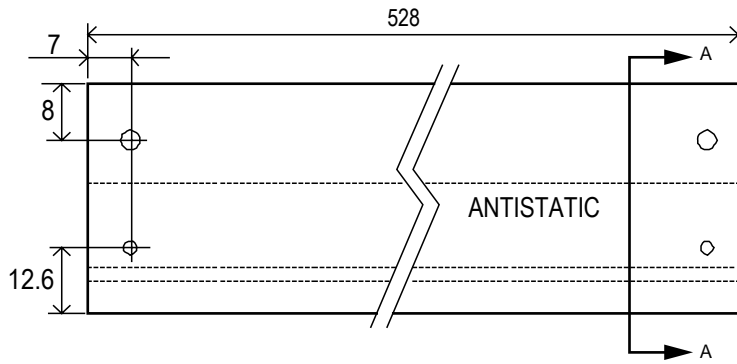

**Tube**  
50 pieces per tube

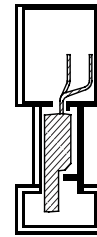

View A-A

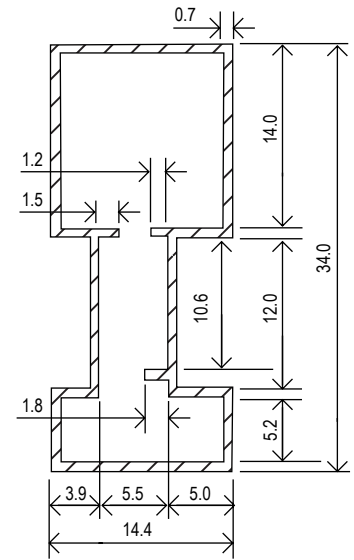

View A-A Enlargement

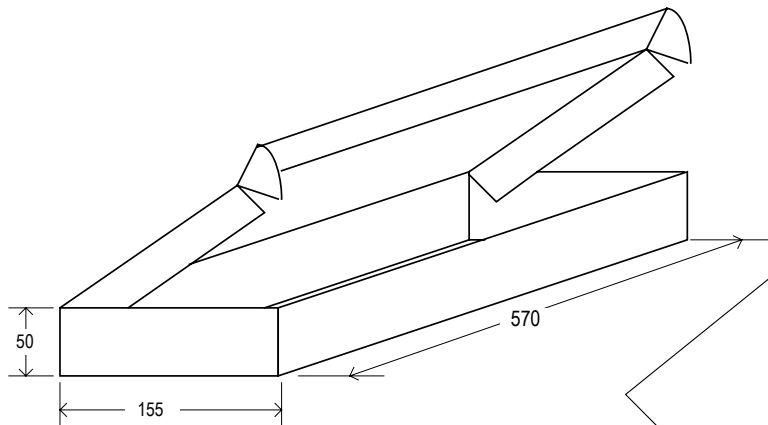

**Inner Carton**  
12 tubes per carton  
600 pieces per inner carton

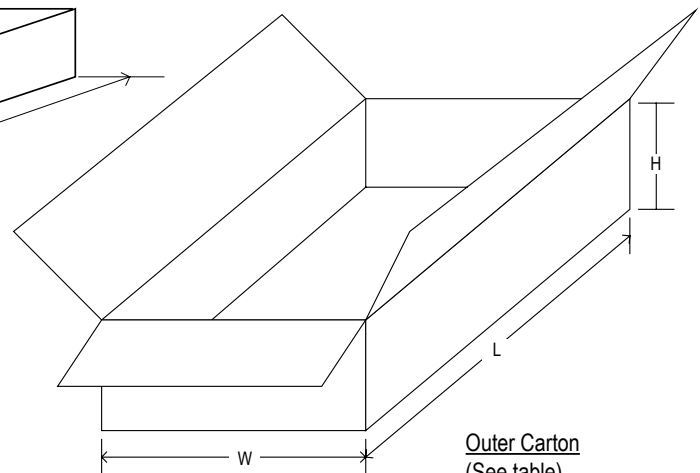

**Outer Carton**  
(See table)

Dimensions in mm

Carton Type	L	W	H	Quantity
Outer Carton A	580	180	140	2 inner cartons, 1200 pieces per outer carton
Outer Carton B	580	335	140	4 inner cartons, 2400 pieces per outer carton

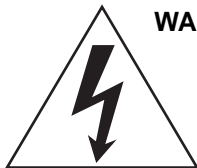

**WARNING** — These devices are designed to be operated at lethal voltages and energy levels. Circuit designs that embody these components must conform with applicable safety requirements. Precautions must be taken to prevent accidental contact with power-line potentials. Do not connect grounded test equipment.

The use of an isolation transformer is recommended during circuit development and breadboarding.

### Cautions for Use

- Operation of the product in parallel to increase current is not permitted.
- Although the product has an internal overtemperature protection circuit, that is intended only to protect the product from temporary excess heating due to overloads. Long-term reliability cannot be guaranteed when the product is operated under continuous overload conditions.

Because reliability can be affected adversely by improper storage environments and handling methods, please observe the following cautions.

### Cautions for Storage

- Ensure that storage conditions comply with the standard temperature (5°C to 35°C) and the standard relative humidity (around 40 to 75%); avoid storage locations that experience extreme changes in temperature or humidity.
- Avoid locations where dust or harmful gases are present and avoid direct sunlight.
- Reinspect for rust on leads and solderability of products that have been stored for a long time.

### Cautions for Testing and Handling

When tests are carried out during inspection testing and other standard test periods, protect the products from power surges from the testing device, shorts between adjacent products, and shorts to the heatsink.

### Remarks About Using Silicone Grease with a Heatsink

- When silicone grease is used in mounting this product on a heatsink, it shall be applied evenly and thinly. If more silicone grease than required is applied, it may produce stress.
- Volatile-type silicone greases may permeate the product and produce cracks after long periods of time, resulting in reduced heat radiation effect, and possibly shortening the lifetime of the product.

- Our recommended silicone greases for heat radiation purposes, which will not cause any adverse effect on the product life, are indicated below:

Type	Suppliers
G746	Shin-Etsu Chemical Co., Ltd.
YG6260	GE Toshiba Silicone Co., Ltd.
SC102	Dow Corning Toray Silicone Co., Ltd.

### Heatsink Mounting Method

**Torque When Tightening Mounting Screws.** The recommended tightening torque for this product package type is: 58.8 to 68.6 N•cm (6.0 to 7.0 kgf•cm).

### Soldering

- When soldering the products, please be sure to minimize the working time, within the following limits:  
260±5°C 10 s  
350±5°C 3 s
- Soldering iron should be at a distance of at least 1.5 mm from the body of the products

### Electrostatic Discharge

- When handling the products, operator must be grounded. Grounded wrist straps worn should have at least 1 MΩ of resistance to ground to prevent shock hazard.
- Workbenches where the products are handled should be grounded and be provided with conductive table and floor mats.
- When using measuring equipment such as a curve tracer, the equipment should be grounded.
- When soldering the products, the head of soldering irons or the solder bath must be grounded in order to prevent leak voltages generated by them from being applied to the products.
- The products should always be stored and transported in our shipping containers or conductive containers, or be wrapped in aluminum foil.

---

*The products described herein are manufactured in Japan by Sanken Electric Co., Ltd. for sale by Allegro MicroSystems, Inc.*

*Sanken and Allegro reserve the right to make, from time to time, such departures from the detail specifications as may be required to permit improvements in the performance, reliability, or manufacturability of its products. Therefore, the user is cautioned to verify that the information in this publication is current before placing any order.*

*The information included herein is believed to be accurate and reliable. Application and operation examples described in this document are given for reference only and Sanken assumes no responsibility for any infringement of industrial property right, intellectual property rights or any other rights of Sanken or any third party which may result from its use.*

*When using the products herein, the applicability and suitability of such products for the intended purpose shall be the users responsibility to determine.*

*Although Sanken undertakes to enhance the quality and reliability of its products, the occurrence of failure and defect of semiconductor products at a certain rate is inevitable.*

*Users of Sanken products are requested to take, at their own risk, preventative measures including safety design of the equipment or systems against any possible injury, death, fires or damages to society due to device failure or malfunction.*

*Sanken products listed in this document are designed and intended for the use as components in general purpose electronic equipment or apparatus (home appliances, office equipment, telecommunication equipment, measuring equipment, etc.). When considering the use of Sanken products in the applications where higher reliability is required (transportation equipment and its control systems, traffic signal control systems or equipment, fire/crime alarm systems, various safety devices, etc.), please contact your nearest Sanken sales representative to discuss and obtain written confirmation of your specifications.*

*The use of Sanken products without the written consent of Sanken in the applications where extremely high reliability is required (aerospace equipment, nuclear power control systems, life support systems, etc.) is strictly prohibited. Anti-radioactive ray design is not considered for the products listed herein.*

Copyright © 2007 Allegro MicroSystems, Inc.  
This datasheet is based on Sanken datasheet SSJ-03339

For the latest version of this document, visit our website:  
[www.allegromicro.com](http://www.allegromicro.com)



Allegro MicroSystems, Inc.  
115 Northeast Cutoff, Box 15036  
Worcester, Massachusetts 01615-0036 (508) 853-5000  
[www.allegromicro.com](http://www.allegromicro.com)

