

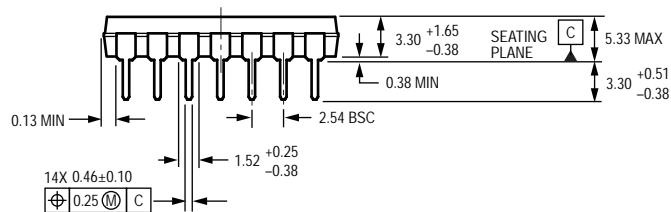

Designator: A Type: 14-pin, 7.62 mm pin spread DIP

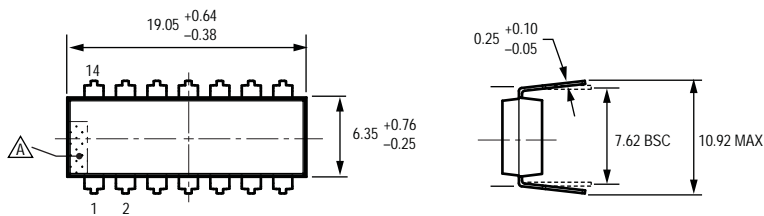
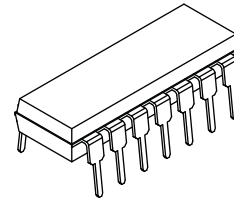

 Terminal #1 mark area

For Reference Only; not for tooling use (reference MS-001AA)
 Dimensions in millimeters
 Dimensions exclusive of mold flash, gate burrs, and dambar protrusions
 Exact case and lead configuration at supplier discretion within limits shown

Designator: A Type: 16-pin, 7.62 mm pin spread DIP

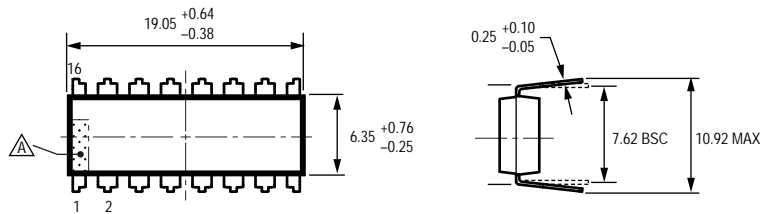
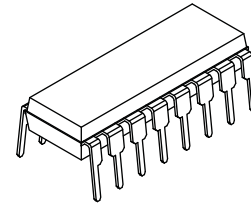

Standard Branding Reference View 1

N = Device part number
 A = Supplier emblem
 Y = Last two digits of year of manufacture
 W = Week of manufacture
 L = Lot number

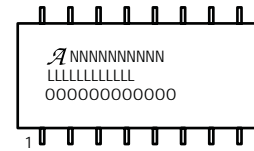
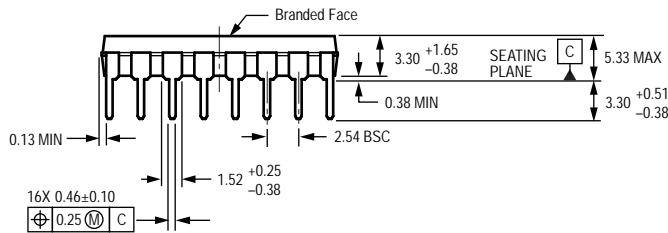

Standard Branding Reference View 2

N = Device part number
 A = Supplier emblem
 L = Lot number
 O = Country of Origin

Terminal #1 mark area

Branding scale and appearance at supplier discretion

For Reference Only: not for tooling use (reference MS-001BB)
 Dimensions in millimeters
 Dimensions exclusive of mold flash, gate burrs, and dambar protrusions
 Exact case and lead configuration at supplier discretion within limits shown

Designator: A Type: 18-pin, 7.62 mm pin spread DIP

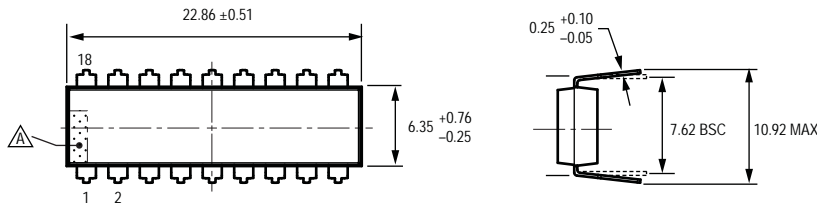
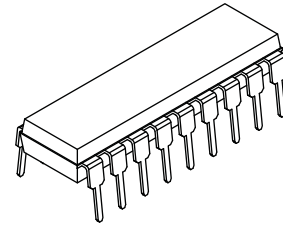

 Standard Branding Reference View

N = Device part number
 A = Supplier emblem
 Y = Last two digits of year of manufacture
 W = Week of manufacture
 L = Lot number

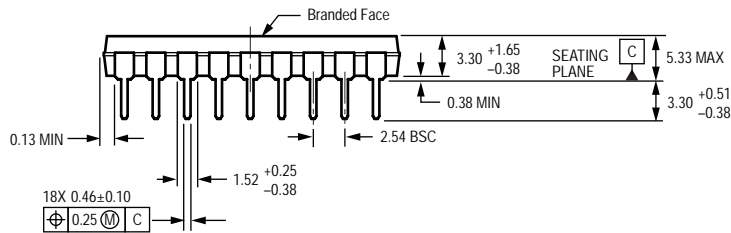

 Terminal #1 mark area

 Branding scale and appearance at supplier discretion

For Reference Only; not for tooling use (reference MS-001AC)
 Dimensions in millimeters

Dimensions exclusive of mold flash, gate burrs, and dambar protrusions
 Exact case and lead configuration at supplier discretion within limits shown

Designator: A Type: 20-pin, 7.62 mm pin spread DIP

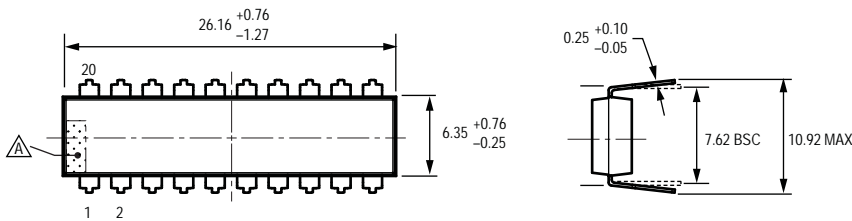
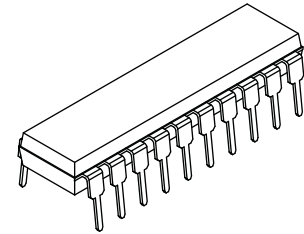

 Standard Branding Reference View

N = Device part number
A = Supplier emblem
Y = Last two digits of year of manufacture
W = Week of manufacture
L = Lot number

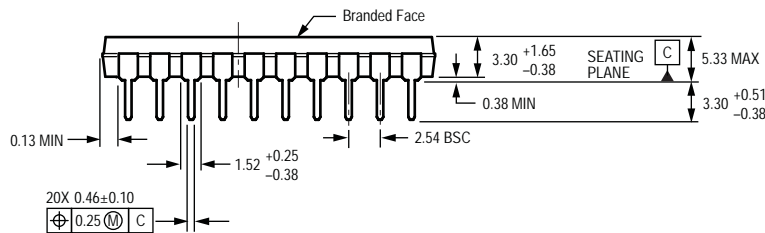

 Terminal #1 mark area

 Branding scale and appearance at supplier discretion

For Reference Only; not for tooling use (reference MS-001AD)
Dimensions in millimeters
Dimensions exclusive of mold flash, gate burrs, and dambar protrusions
Exact case and lead configuration at supplier discretion within limits shown

Designator: A Type: 22-pin, 10.16 mm pin spread DIP

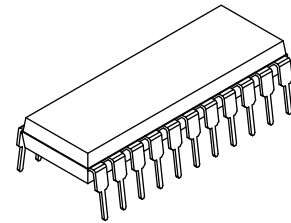
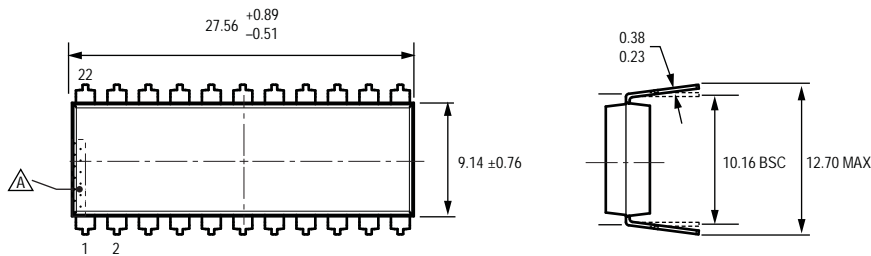

 Standard Branding Reference View

N = Device part number
 A = Supplier emblem
 Y = Last two digits of year of manufacture
 W = Week of manufacture
 L = Lot number

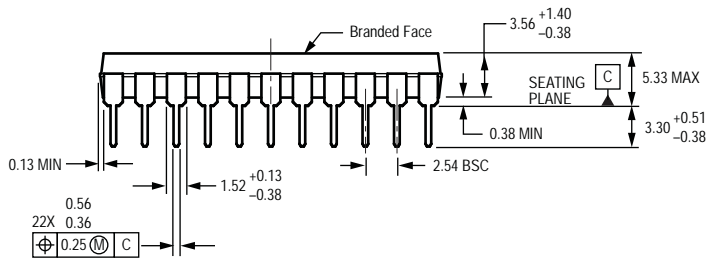

 Terminal #1 mark area

 Branding scale and appearance at supplier discretion

For Reference Only; not for tooling use (reference MS-010AA)

Dimensions in millimeters

Dimensions exclusive of mold flash, gate burrs, and dambar protrusions

Exact case and lead configuration at supplier discretion within limits shown

Designator: A Type: 24-pin, 7.62 mm pin spread DIP

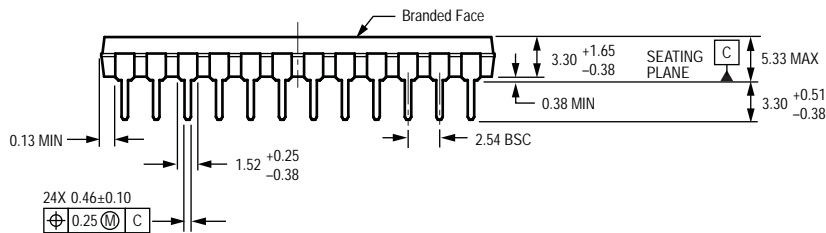
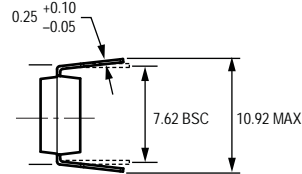
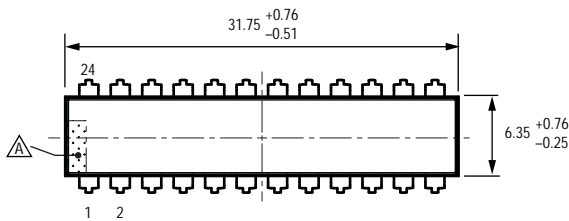
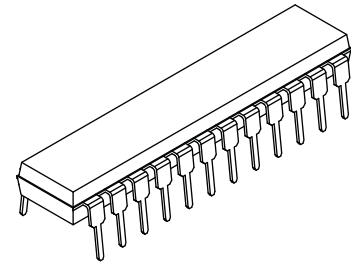

 Standard Branding Reference View

N = Device part number
 A = Supplier emblem
 Y = Last two digits of year of manufacture
 W = Week of manufacture
 L = Lot number

 Terminal #1 mark area

 Branding scale and appearance at supplier discretion

For Reference Only; not for tooling use (reference MS-001AF)
 Dimensions in millimeters

Dimensions exclusive of mold flash, gate burrs, and dambar protrusions
 Exact case and lead configuration at supplier discretion within limits shown

Designator: A Type: 28-pin, 15.24 mm pin spread DIP

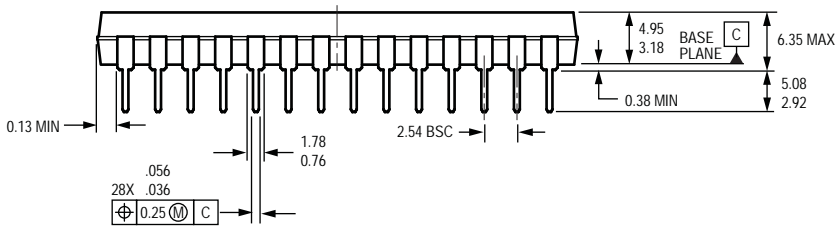
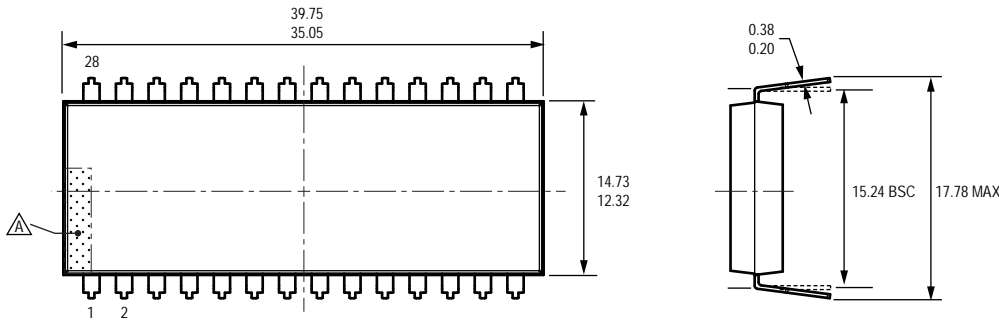
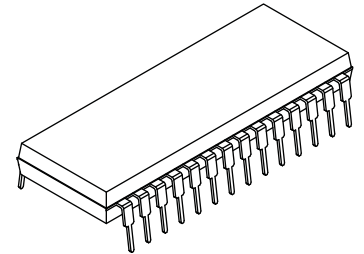

 Terminal #1 mark area

For Reference Only; not for tooling use (reference MS-011AB)
Dimensions in millimeters
Dimensions exclusive of mold flash, gate burrs, and dambar protrusions
Exact case and lead configuration at supplier discretion within limits shown

Designator: B

Type: 16-pin, 7.62 mm pin spread DIP with internally fused pins for thermal dissipation

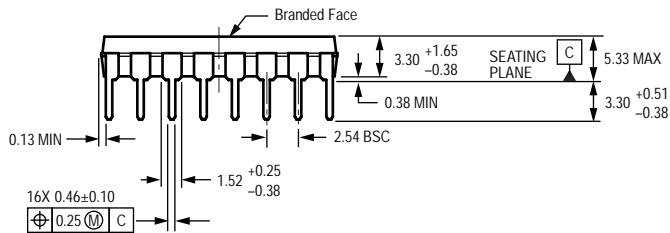
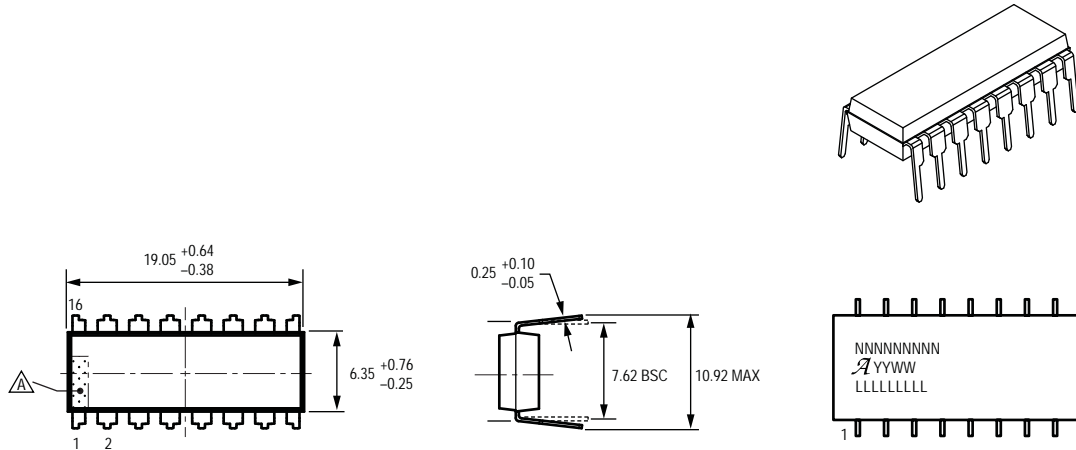

 Standard Branding Reference View

N = Device part number
 A = Supplier emblem
 Y = Last two digits of year of manufacture
 W = Week of manufacture
 L = Lot number

 Terminal #1 mark area

 Branding scale and appearance at supplier discretion

For Reference Only; not for tooling use (reference MS-001BB)

Dimensions in millimeters

Dimensions exclusive of mold flash, gate burrs, and dambar protrusions

Exact case and lead configuration at supplier discretion within limits shown

Internal configuration of fused pins is device-dependent

Designator: B

Type: 16-pin, 7.62 mm pin spread DIP with externally fused pins for thermal dissipation

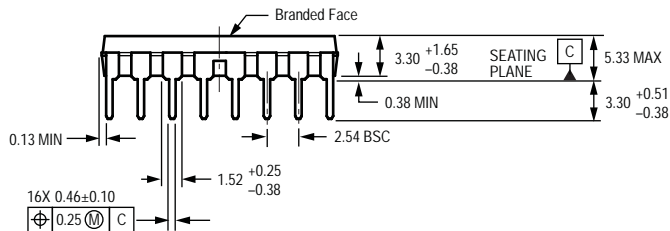
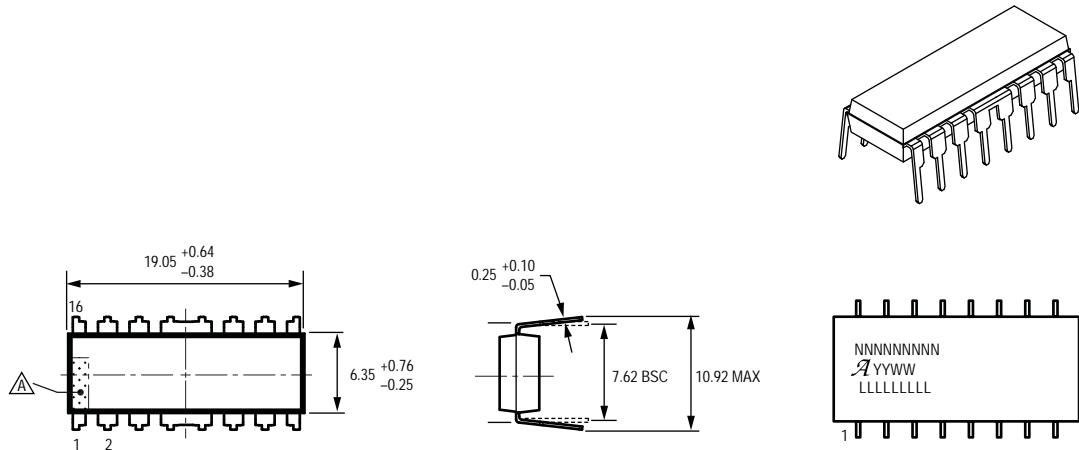

 Standard Branding Reference View

N = Device part number
 A = Supplier emblem
 Y = Last two digits of year of manufacture
 W = Week of manufacture
 L = Lot number

 Terminal #1 mark area

 Branding scale and appearance at supplier discretion

For Reference Only; not for tooling use (reference MS-001BB)
 Dimensions in millimeters
 Dimensions exclusive of mold flash, gate burrs, and dambar protrusions
 Exact case and lead configuration at supplier discretion within limits shown

**Internal and external configuration of fused pins is device-dependent;
 2 pins each side**

Designator: B

Type: 22-pin, 10.16 mm pin spread DIP with internally fused pins for thermal dissipation

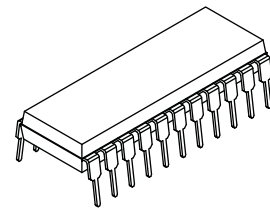
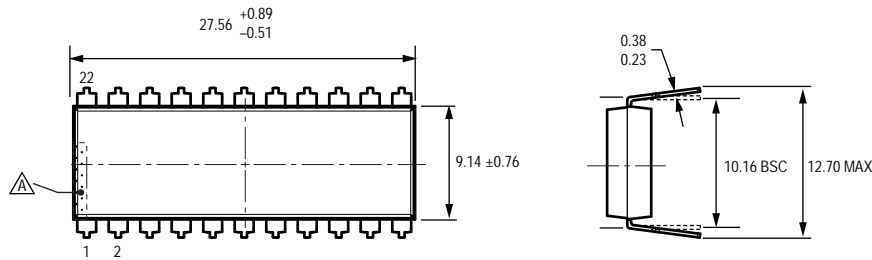

 Standard Branding Reference View

N = Device part number
 A = Supplier emblem
 Y = Last two digits of year of manufacture
 W = Week of manufacture
 L = Lot number

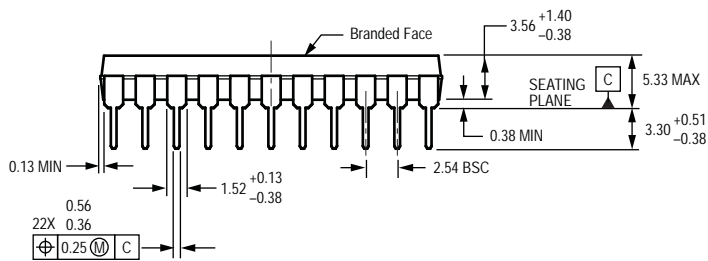

 Terminal #1 mark area

 Branding scale and appearance at supplier discretion

For Reference Only; not for tooling use (reference MS-010AA)
 Dimensions in millimeters

Dimensions exclusive of mold flash, gate burrs, and dambar protrusions
 Exact case and lead configuration at supplier discretion within limits shown

Internal configuration of fused pins is device-dependent

Copyright ©2008, Allegro MicroSystems, Inc. Drawings are for reference only; not for tooling use. Allegro MicroSystems, Inc. reserves the right to make, from time to time, such departures from the detail specifications as may be required to permit improvements in the performance, reliability, or manufacturability of its products. Before placing an order, the user is cautioned to verify that the information being relied upon is current. The information included herein is believed to be accurate and reliable. However, Allegro MicroSystems, Inc. assumes no responsibility for its use; nor for any infringement of patents or other rights of third parties which may result from its use.

Designator: B

Type: 24-pin, 7.62 mm pin spread DIP with internally fused pins for thermal dissipation

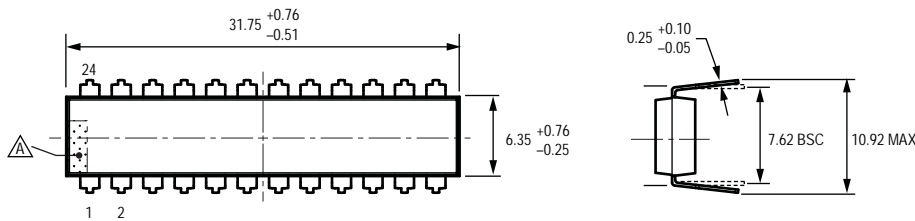
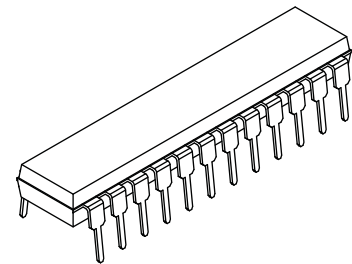

 Standard Branding Reference View

N = Device part number
 A = Supplier emblem
 Y = Last two digits of year of manufacture
 W = Week of manufacture
 L = Lot number

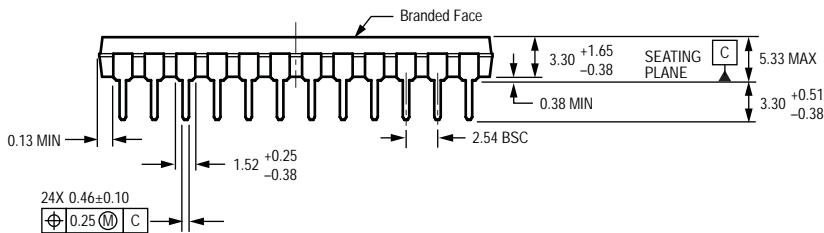

 Terminal #1 mark area

 Branding scale and appearance at supplier discretion

For Reference Only; not for tooling use (reference MS-001AF)
 Dimensions in millimeters

Dimensions exclusive of mold flash, gate burrs, and dambar protrusions
 Exact case and lead configuration at supplier discretion within limits shown

Internal configuration of fused pins is device-dependent

Designator: B

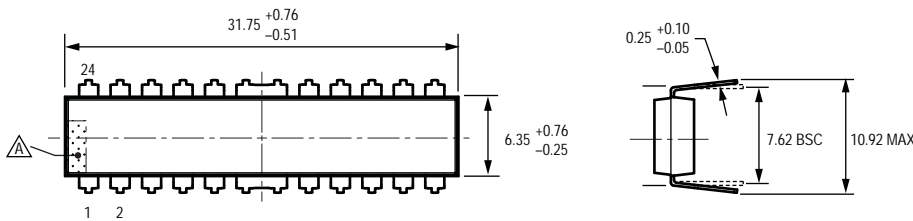
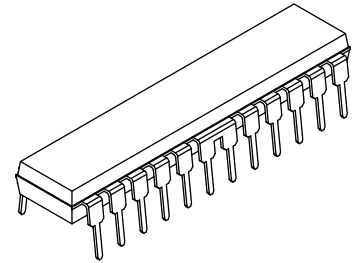

Type: 24-pin, 7.62 mm pin spread DIP with externally fused pins for thermal dissipation

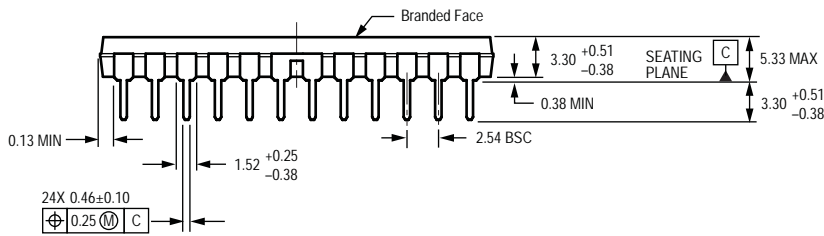

 Standard Branding Reference View

N = Device part number
 A = Supplier emblem
 Y = Last two digits of year of manufacture
 W = Week of manufacture
 L = Lot number



-  Terminal #1 mark area
-  Branding scale and appearance at supplier discretion

For Reference Only; not for tooling use (reference MS-001AF)
 Dimensions in millimeters
 Dimensions exclusive of mold flash, gate burrs, and dambar protrusions
 Exact case and lead configuration at supplier discretion within limits shown

**Internal and external configuration of fused pins is device-dependent;
 2 or 3 pins each side**

Copyright ©2008, Allegro MicroSystems, Inc. Drawings are for reference only; not for tooling use. Allegro MicroSystems, Inc. reserves the right to make, from time to time, such departures from the detail specifications as may be required to permit improvements in the performance, reliability, or manufacturability of its products. Before placing an order, the user is cautioned to verify that the information being relied upon is current. The information included herein is believed to be accurate and reliable. However, Allegro MicroSystems, Inc. assumes no responsibility for its use; nor for any infringement of patents or other rights of third parties which may result from its use.

Designator: *M* Type: 8-pin, 7.62 mm pin spread DIP

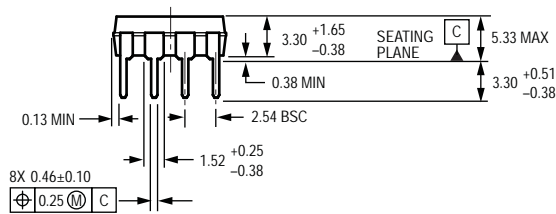
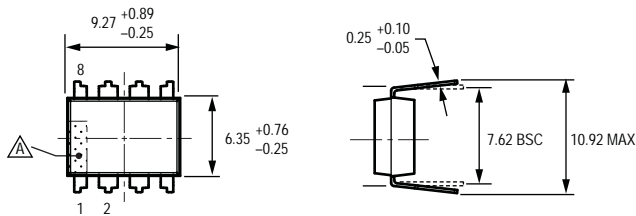
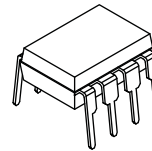

 Terminal #1 mark area

For Reference Only; not for tooling use (reference MS-001BA)
Dimensions in millimeters
Dimensions exclusive of mold flash, gate burrs, and dambar protrusions
Exact case and lead configuration at supplier discretion within limits shown