

Designator: EA

Type: 28-pin, square PLCC with internally fused pins for thermal dissipation

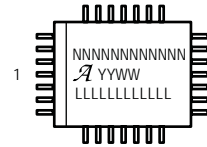
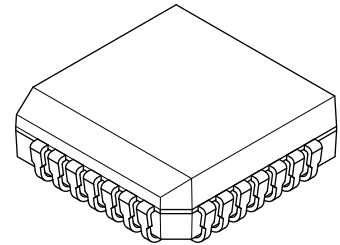
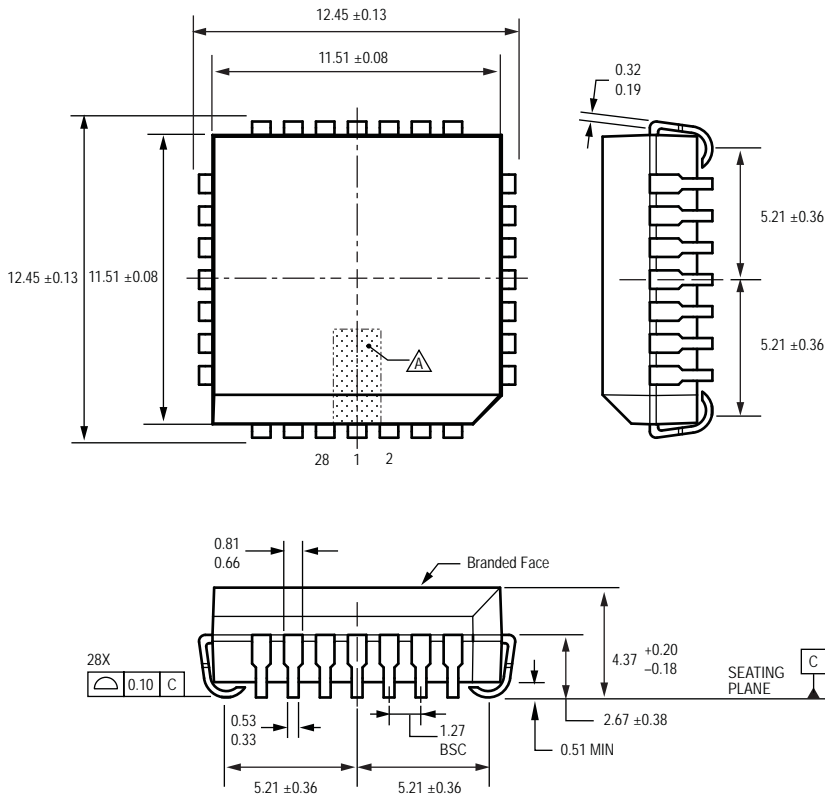

 Standard Branding Reference View

N = Device part number
 A = Supplier emblem
 Y = Last two digits of year of manufacture
 W = Week of manufacture
 L = Lot number

For Reference Only; not for tooling use (reference MS-018 AB)
 Dimensions in millimeters
 Dimensions exclusive of mold flash, gate burrs, and dambar protrusions
 Exact case and lead configuration at supplier discretion within limits shown

 Terminal #1 mark area

 Branding scale and appearance at supplier discretion

Fused pins on side opposite pin 1; internal configuration of fused pins is device-dependent

Designator: EB

Type: 28-pin, square PLCC with internally fused pins for thermal dissipation

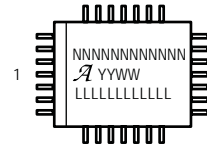
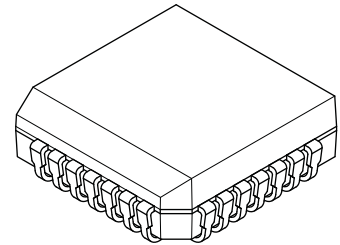

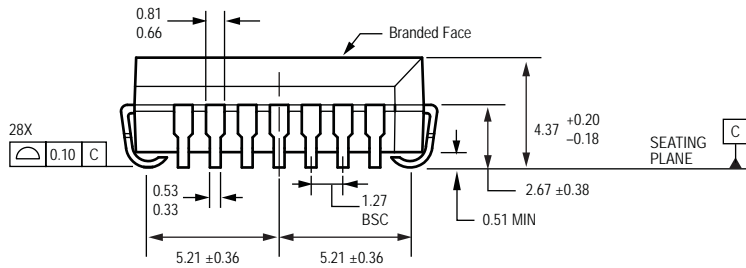
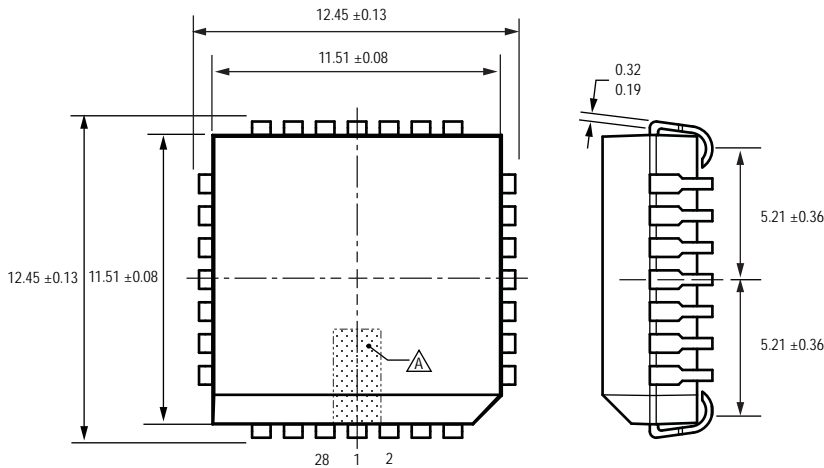

 Standard Branding Reference View

N = Device part number
 A = Supplier emblem
 Y = Last two digits of year of manufacture
 W = Week of manufacture
 L = Lot number



For Reference Only; not for tooling use (reference MS-018 AB)
 Dimensions in millimeters
 Dimensions exclusive of mold flash, gate burrs, and dambar protrusions
 Exact case and lead configuration at supplier discretion within limits shown

-  Terminal #1 mark area
-  Branding scale and appearance at supplier discretion

Fused pins on two opposite sides; internal configuration of fused pins is device-dependent

Copyright ©2008-2010, Allegro MicroSystems, Inc. Drawings are for reference only; not for tooling use. Allegro MicroSystems, Inc. reserves the right to make, from time to time, such departures from the detail specifications as may be required to permit improvements in the performance, reliability, or manufacturability of its products. Before placing an order, the user is cautioned to verify that the information being relied upon is current. The information included herein is believed to be accurate and reliable. However, Allegro MicroSystems, Inc. assumes no responsibility for its use; nor for any infringement of patents or other rights of third parties which may result from its use.

Designator: EB

Type: 44-pin, square PLCC with internally fused pins for thermal dissipation

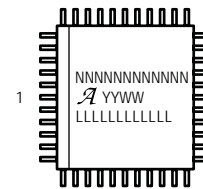
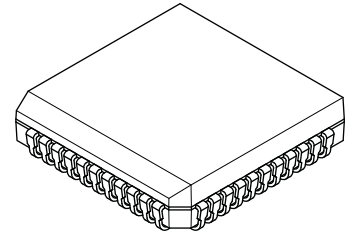
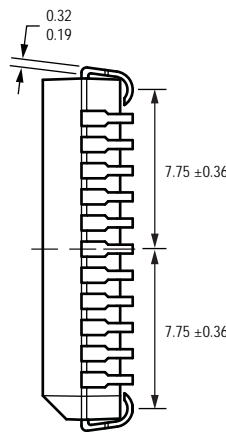
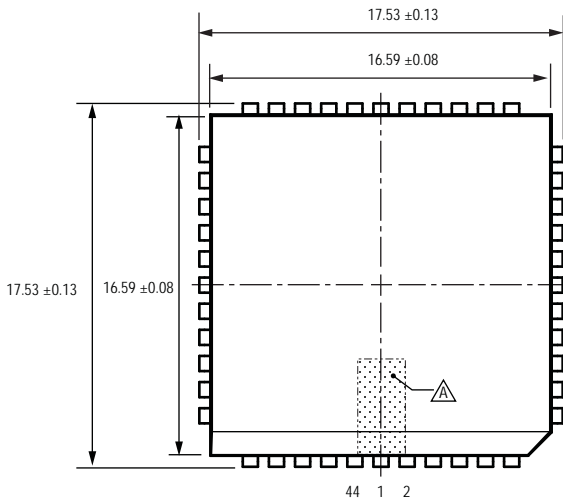

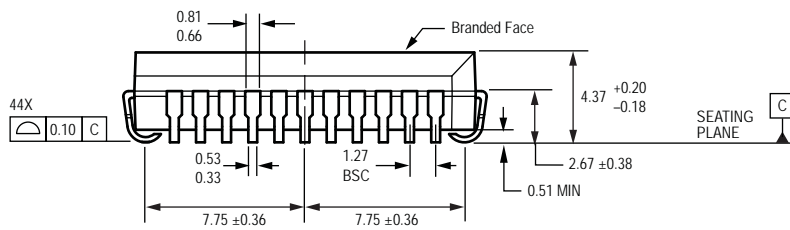

 Standard Branding Reference View

N = Device part number
 A = Supplier emblem
 Y = Last two digits of year of manufacture
 W = Week of manufacture
 L = Lot number



For Reference Only; not for tooling use (reference MS-018 AC)
 Dimensions in millimeters
 Dimensions exclusive of mold flash, gate burrs, and dambar protrusions
 Exact case and lead configuration at supplier discretion within limits shown

 Terminal #1 mark area
 Branding scale and appearance at supplier discretion

Fused pins on two opposite sides; internal configuration of fused pins is device-dependent

Copyright ©2008-2010, Allegro MicroSystems, Inc. Drawings are for reference only; not for tooling use. Allegro MicroSystems, Inc. reserves the right to make, from time to time, such departures from the detail specifications as may be required to permit improvements in the performance, reliability, or manufacturability of its products. Before placing an order, the user is cautioned to verify that the information being relied upon is current. The information included herein is believed to be accurate and reliable. However, Allegro MicroSystems, Inc. assumes no responsibility for its use; nor for any infringement of patents or other rights of third parties which may result from its use.

Designator: ED

Type: 44-pin, square PLCC with internally fused pins for thermal dissipation

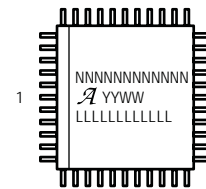
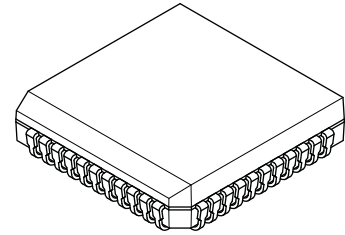
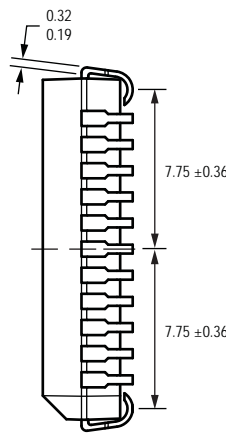
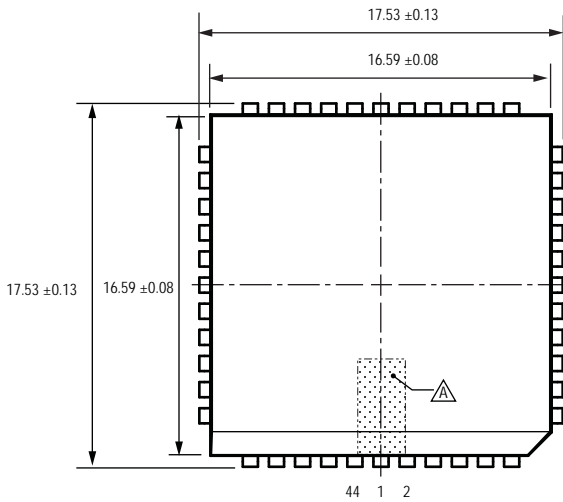

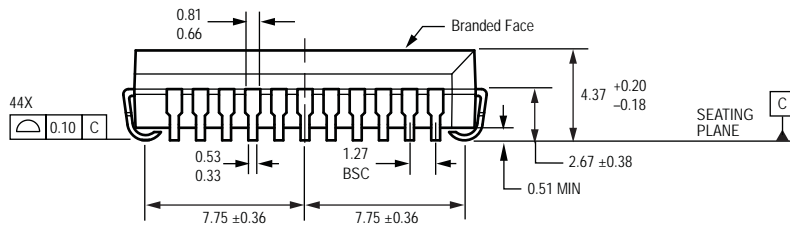

 Standard Branding Reference View

N = Device part number
 A = Supplier emblem
 Y = Last two digits of year of manufacture
 W = Week of manufacture
 L = Lot number



For Reference Only; not for tooling use (reference MS-018 AC)
 Dimensions in millimeters
 Dimensions exclusive of mold flash, gate burrs, and dambar protrusions
 Exact case and lead configuration at supplier discretion within limits shown

 Terminal #1 mark area
 Branding scale and appearance at supplier discretion

Fused pins on four sides; internal configuration of fused pins is device-dependent

Copyright ©2008-2010, Allegro MicroSystems, Inc. Drawings are for reference only; not for tooling use. Allegro MicroSystems, Inc. reserves the right to make, from time to time, such departures from the detail specifications as may be required to permit improvements in the performance, reliability, or manufacturability of its products. Before placing an order, the user is cautioned to verify that the information being relied upon is current. The information included herein is believed to be accurate and reliable. However, Allegro MicroSystems, Inc. assumes no responsibility for its use; nor for any infringement of patents or other rights of third parties which may result from its use.

Designator: EP
Type: 28-pin, square PLCC

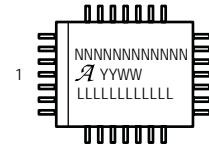
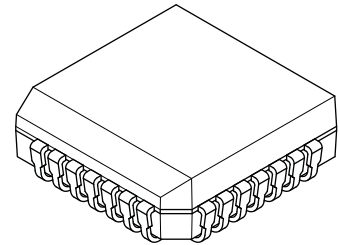
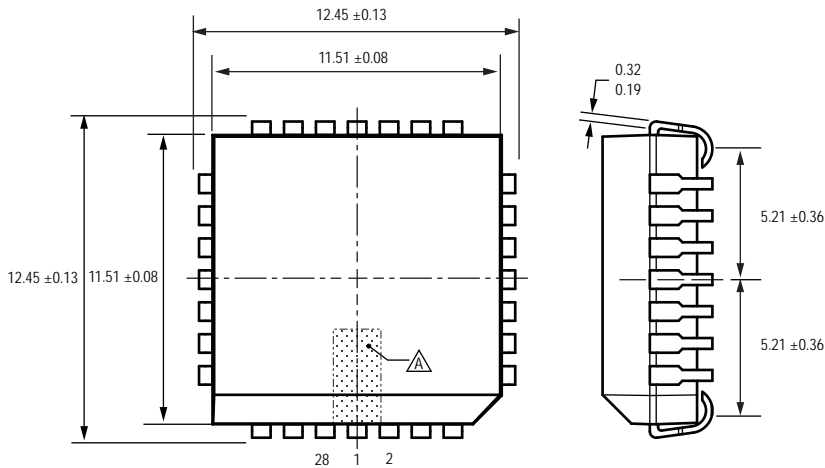

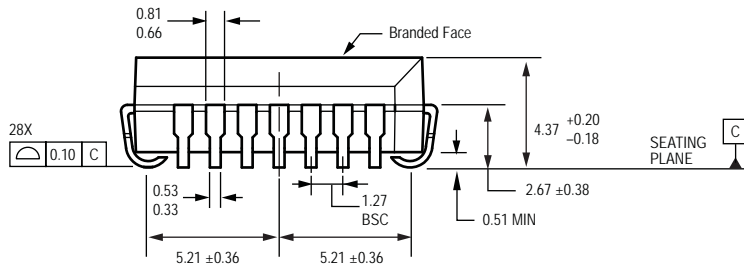

 Standard Branding Reference View

N = Device part number
 A = Supplier emblem
 Y = Last two digits of year of manufacture
 W = Week of manufacture
 L = Lot number



For Reference Only; not for tooling use (reference MS-018 AB)
 Dimensions in millimeters
 Dimensions exclusive of mold flash, gate burrs, and dambar protrusions
 Exact case and lead configuration at supplier discretion within limits shown

-  Terminal #1 mark area
-  Branding scale and appearance at supplier discretion

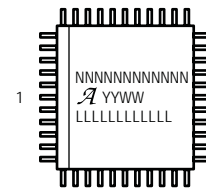
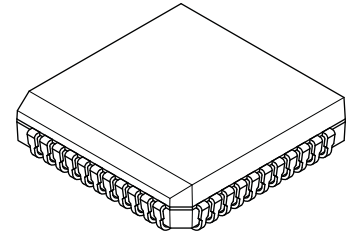
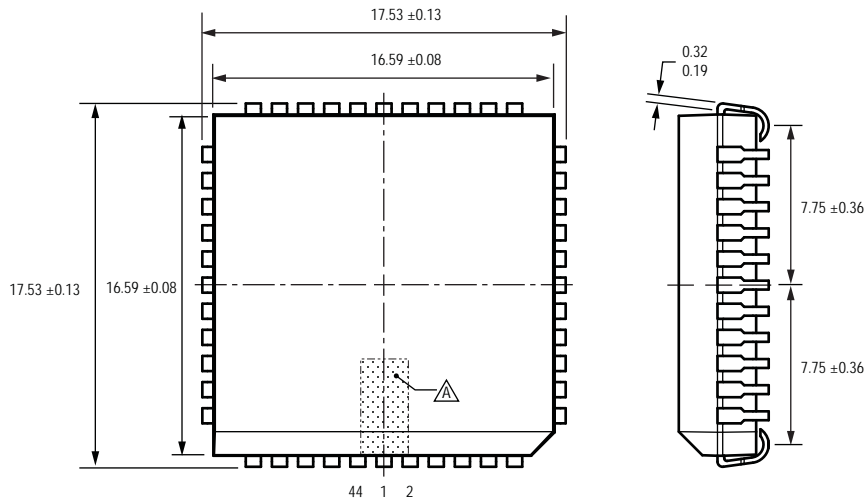

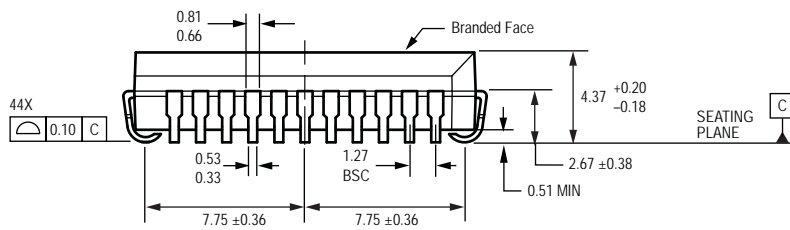

 Standard Branding Reference View

N = Device part number
 A = Supplier emblem
 Y = Last two digits of year of manufacture
 W = Week of manufacture
 L = Lot number



For Reference Only: not for tooling use (reference MS-018 AC)
 Dimensions in millimeters
 Dimensions exclusive of mold flash, gate burrs, and dambar protrusions
 Exact case and lead configuration at supplier discretion within limits shown

-  Terminal #1 mark area
-  Branding scale and appearance at supplier discretion

Designator: EQ Type: 32-pin, rectangular PLCC

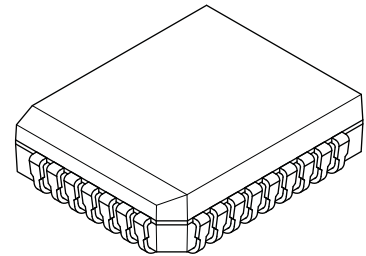
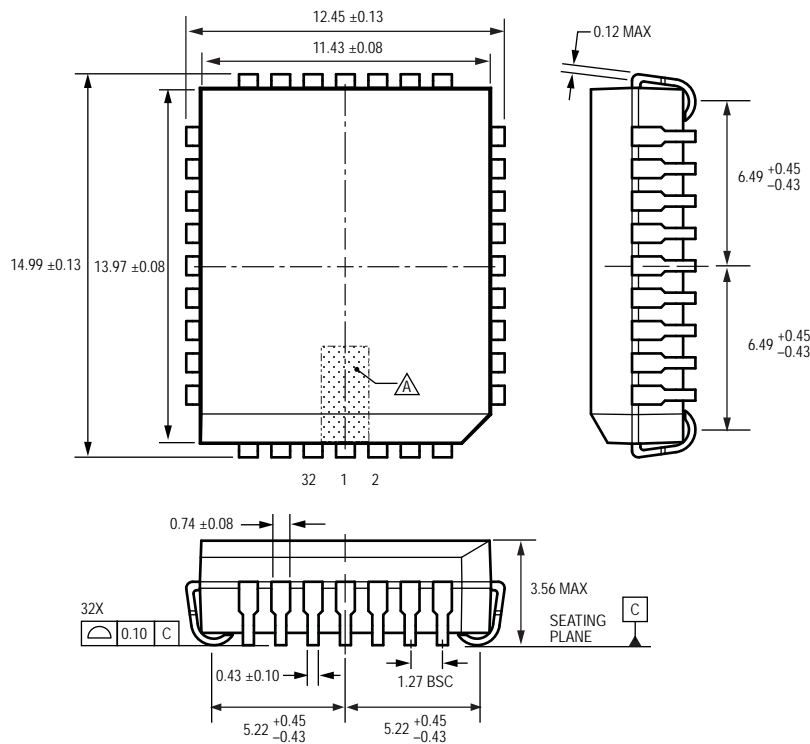

For Reference Only; not for tooling use (reference MS-016 AE)
 Dimensions in millimeters
 Dimensions exclusive of mold flash, gate burrs, and dambar protrusions
 Exact case and lead configuration at supplier discretion within limits shown

 Terminal #1 mark area

Designator: JP

Type: 48-pin LQFP with exposed thermal pad

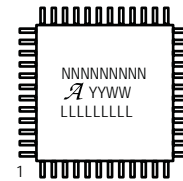
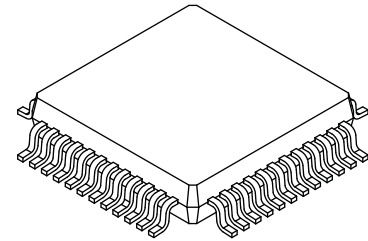

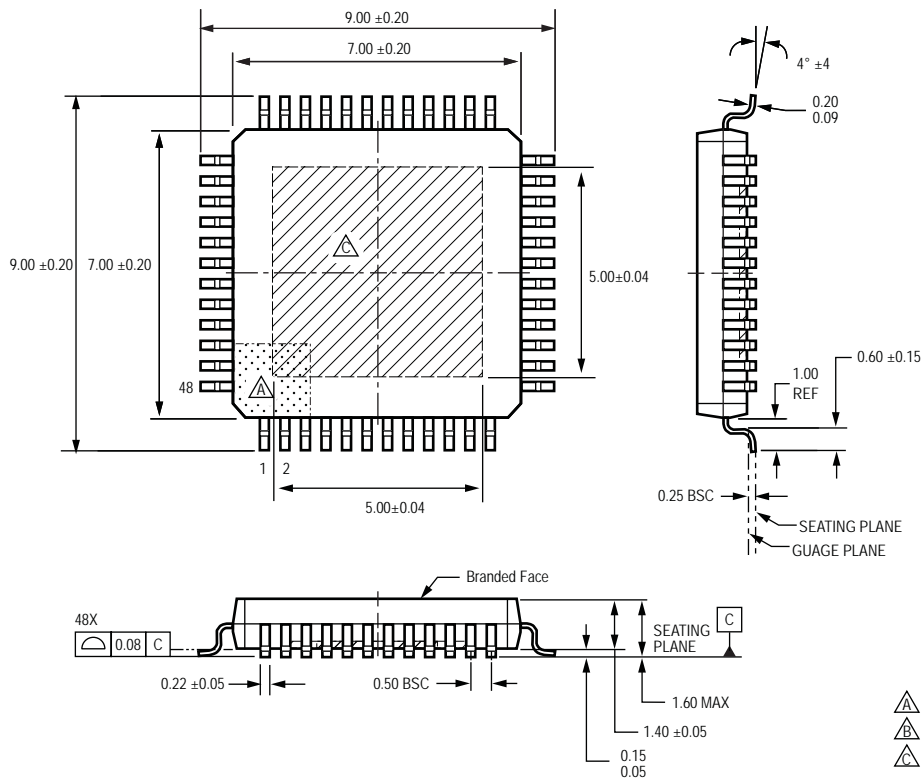

 Standard Branding Reference View

N = Device part number
 A = Supplier emblem
 Y = Last two digits of year of manufacture
 W = Week of manufacture
 L = Lot number



For Reference Only; not for tooling use (reference MS-026 BBCHD)
 Dimensions in millimeters
 Dimensions exclusive of mold flash, gate burrs, and dambar protrusions
 Exact case and lead configuration at supplier discretion within limits shown

-  Terminal #1 mark area
-  Branding scale and appearance at supplier discretion
-  Exposed thermal pad (bottom surface); exact dimensions may vary with device

Designator: JS

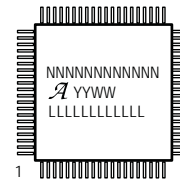
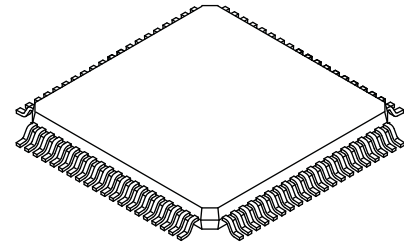
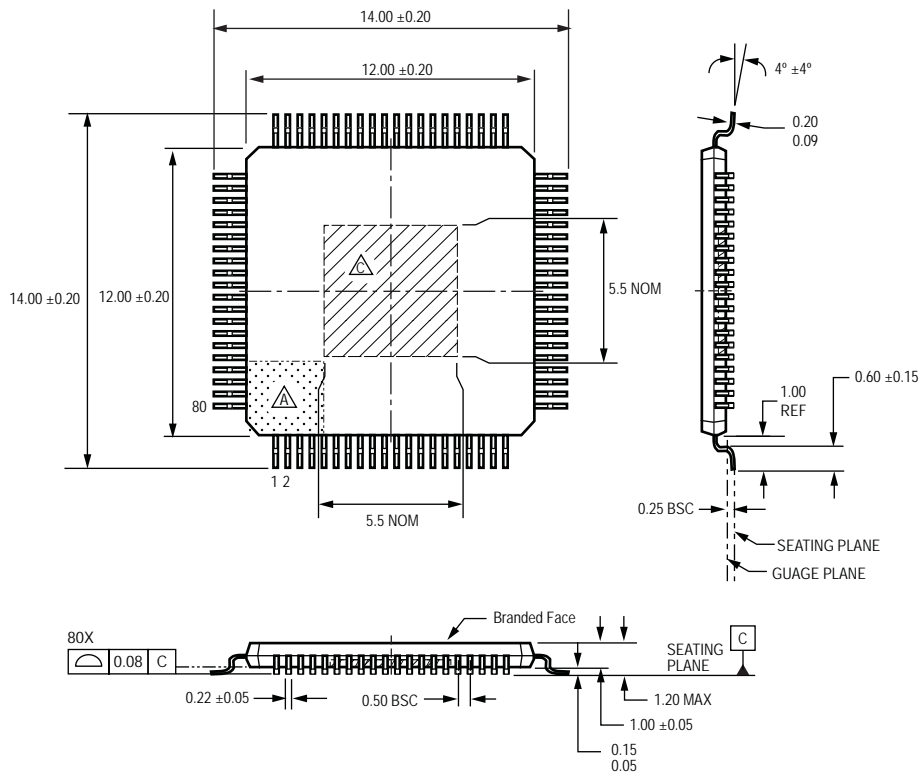

Type: 80-pin TQFP with exposed thermal pad



Standard Branding Reference View

N = Device part number
 A = Supplier emblem
 Y = Last two digits of year of manufacture
 W = Week of manufacture
 L = Lot number

For Reference Only; not for tooling use (reference MS-026 ADDHD)
 Dimensions in millimeters
 Dimensions exclusive of mold flash, gate burrs, and dambar protrusions
 Exact case and lead configuration at supplier discretion within limits shown

-  Terminal #1 mark area
-  Branding scale and appearance at supplier discretion
-  Exposed thermal pad (bottom surface); pad dimensions may vary with device

Designator: JU
Type: 48-pin TQFP

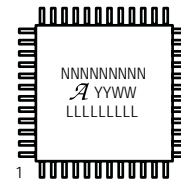
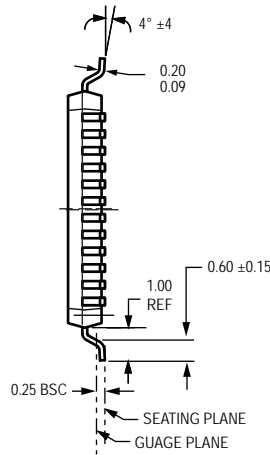
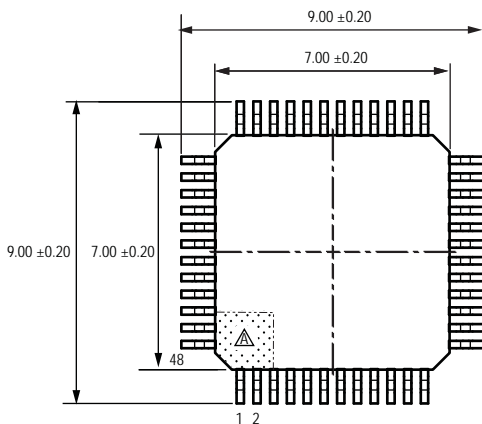
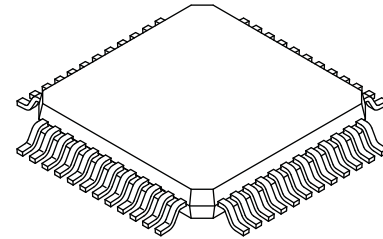

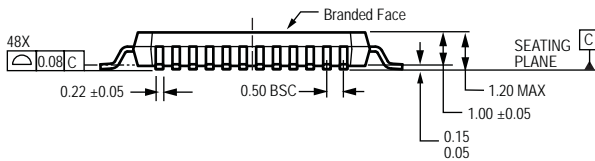

 Standard Branding Reference View

N = Device part number
 A = Supplier emblem
 Y = Last two digits of year of manufacture
 W = Week of manufacture
 L = Lot number



For Reference Only; not for tooling use (reference MS-026 ABC)
 Dimensions in millimeters
 Dimensions exclusive of mold flash, gate burrs, and dambar protrusions
 Exact case and lead configuration at supplier discretion within limits shown

-  Terminal #1 mark area
-  Branding scale and appearance at supplier discretion