

# METHOD FOR MECHANICAL MOUNTING TOLERANCE COMPENSATION ON ALLEGRO SPEED SENSORS

By Cedric Gillet, Florian Kulla, and Yannick Vuillemermet  
Allegro MicroSystems, LLC

## INTRODUCTION

Accuracy requirements for absolute mechanical edge detection on cam sensors and more generally on engine management speed sensors have noticeably increased with the need for power optimization and emissions control in car engines being sold today.

Through several generations of speed sensors, Allegro MicroSystems has implemented signal processing enhancements allowing for improved accuracy and providing solutions meeting stringent specification requirements.

Improvements on sensor accuracy are such that errors from mechanical positioning of the finished module occupy a significant part of the total error budget specified by the OEM. A need for compensation of such mechanical error has emerged on the market and this application note describes a method to compensate for it using the Allegro ATS679PSL cam sensor. This device was selected as one example of Allegro speed sensors among others that have threshold adjustment capability, a feature allowing for mechanical error compensation.

## MECHANICAL ERROR

The purpose of speed position sensors like the Allegro ATS679PSL is to generate an electrical output that accurately represents the absolute mechanical profile. A shift in the electrical edge position will affect the engine timings, generating undesired effects such as overconsumption, and must therefore be avoided.

Applications using the ATS679PSL programmed with optimal configuration (learning n-tooth memory mitigating run-out effects, ideal 70% switch point position) point to mechanical misalignment as the largest contributor

to sensor output error. This mechanical misalignment is cumulative through all assembly steps the device encounters. These steps include die integration to the Allegro SL package, SL package processing (often overmolding) into a finished sensor module, and finally mounting on the engine.

Ideally, the methodology proposed in this document to compensate for mechanical error should be applied to the final step, when the cam sensor has been mounted on the engine. Since this compensation step is usually neither desired nor possible on engine, the realistic option is to compensate for it when the finished sensor module is being tested. This is the assumption that will be made in this document.

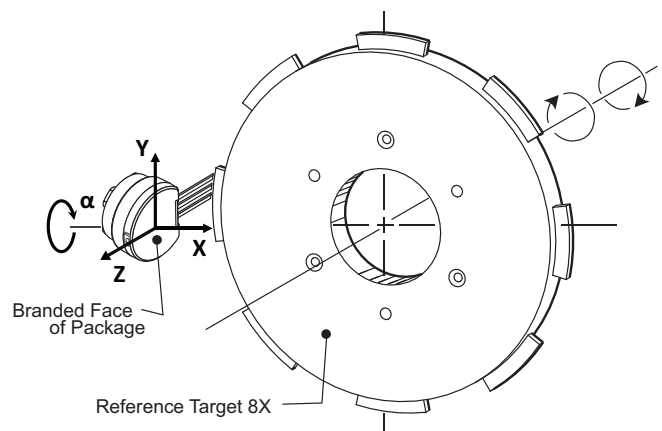

Figure 1: Axes definition for mechanical misalignments on Allegro's ATS679PSL in front of gear tooth target

The possible errors generated by mechanical assembly are subsequently described with reference to the axis referential defined in Figure 1.

### Error Along X Axis (Radial Axis)

Sensor shift along the X axis will impact signal amplitude and slope change. This is referred to the air gap effect, air gap being the distance from the branded face of the package to the target tooth. Like many Allegro speed sensors, the ATS679PSL is equipped with signal peak tracking, allowing for signal amplitude normalization and defining output switch point as a percentage of the signal amplitude. A normalized mapping of a target over various air gap positions reveals a specific intersection threshold level that does not change over the full air gap mounting tolerance range. For example, on the ATS679PSL, a threshold defined to 70% of signal amplitude (30% from tooth) ensures that switch point error over full air gap range (0.5 to 3.0 mm) can stay below  $\pm 0.05$  degrees. This is illustrated in Figure 2 and confirmed in Figure 10.

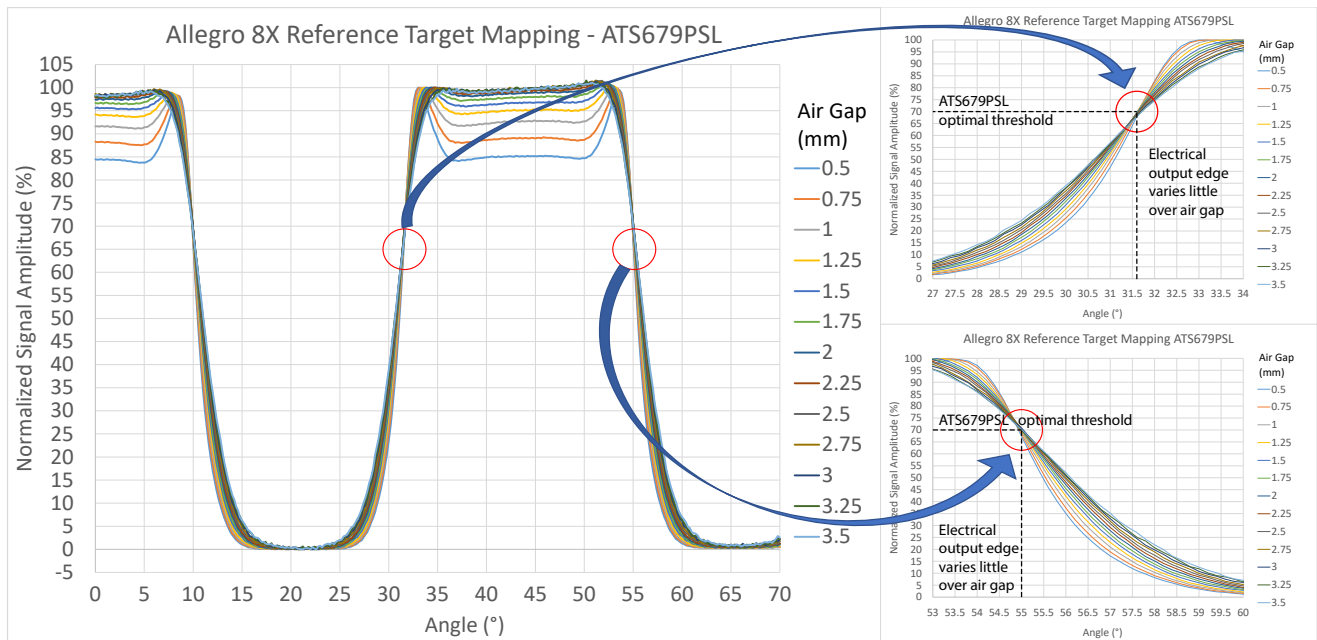

Figure 2: Definition of ideal threshold level with ATS679PSL on Allegro 8X reference target mapping over air gap (X axis)

### Error Along Y Axis (Tangential Axis)

Sensor shift along the Y axis will generate an electrical edge accuracy error directly proportional to the amount of mechanical shift along Y. This can be defined by Equation 1 below and illustrated in Figure 3 and Figure 5.

$$\theta = \tan^{-1}\left(\frac{Y}{AG + R}\right) \quad (1)$$

where  $\theta$  is the angle error in degrees, Y is the mechanical error along Y axis (mm), AG is the air gap (mm), and R is the target radius (mm).

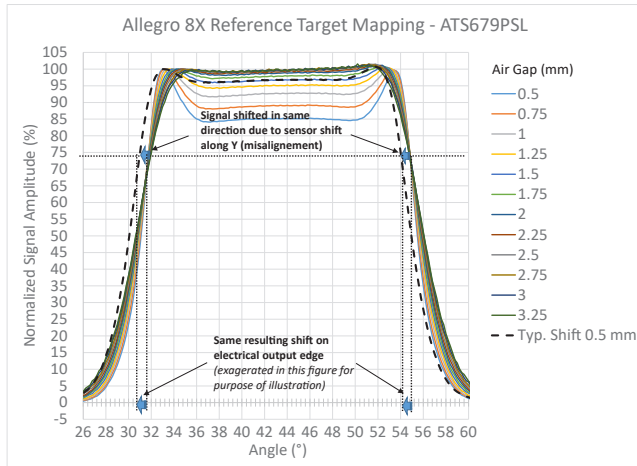

Figure 3: Signal shift due to sensor misplacement along Y axis – Full signal tooth is shifted.

A strong dependency over target radius can be observed (see Figure 4). For example, at 1.5 mm of air gap, 0.5 mm of sensor misalignment along the Y axis will generate 0.47 degrees of error on a 120 mm target diameter and 1.08 degrees of error on a 50 mm target diameter. The need for mechanical compensation along the Y axis is critical for cam targets that are designed to be as small as possible (around 50 mm diameter).

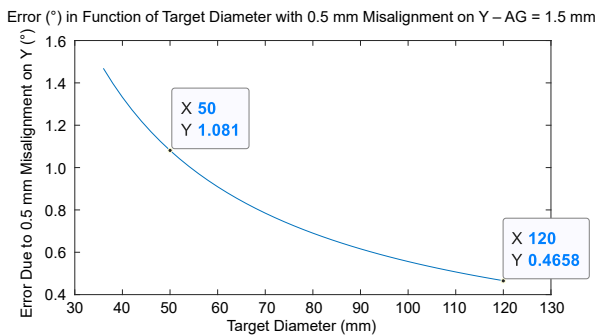

Figure 4: Electrical signal error in function of target diameter, at 0.5 mm of misplacement along Y axis.

Figure 5 illustrates electrical error in degrees in function of target diameter for a misalignment range of  $\pm 0.5$  mm along the Y axis.

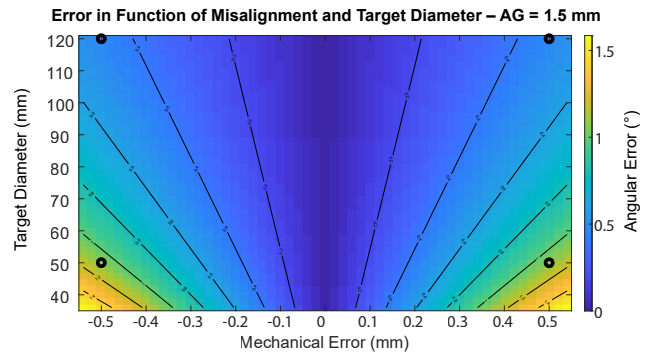

Figure 5: Electrical signal error (°) in function of mechanical misalignment along Y axis and target diameter. The small black circles correspond to the points marked in Figure 4.

### Error Along Z Axis (Axial Axis)

Shifting the sensor along the Z axis does not affect the signal amplitude nor its phase. Magnetic simulations and measurements show that a sensor misalignment along the Z axis of  $\pm 1.5$  mm from the center does not generate an electrical edge error larger than  $0.15^\circ$  for a 5 mm target width (Figure 6).

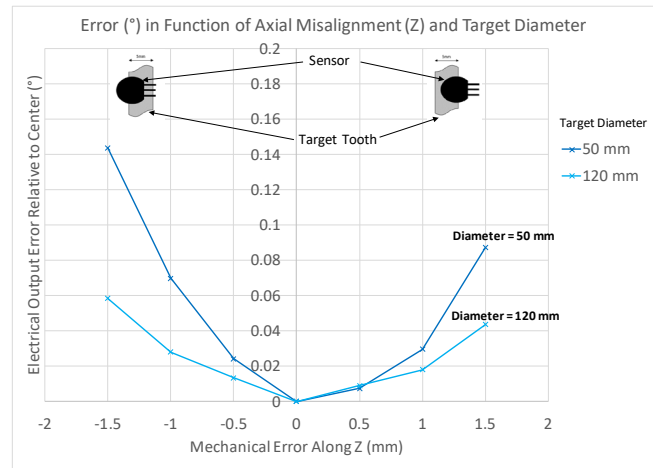

Figure 6: Electrical signal error (°) in function of mechanical misalignment along Z axis and target diameter. Non-symmetry is explained by the SL magnet non-symmetrical shape.

### Error Along $\alpha$ Axis (Twist)

The ATS679PSL is a single Hall element speed sensor, meaning that it is capable of sensing in any orientation ( $\alpha$  rotation). Magnetic simulations and measurements have confirmed that a small sensor twist along  $\alpha$  axis (in the range of  $\pm 10$  degrees) does not impact the signal amplitude nor the electrical edge accuracy. The maximum error obtained

with ±10 degrees of twist along α stays below 0.05°.

Among previously described errors, misalignment along the Y axis was observed to be the major contributor to total sensor error and this is therefore the axis which requires the focus for mitigation.

## THRESHOLD ADJUSTMENTS METHOD

On the ATS679PSL, the switching threshold can be programmed through EEPROM memory to levels between 10% to 90% of magnetic signal peak-to-peak with a 0.8% step size. Additionally, the magnetic rising switching threshold (B<sub>OP</sub>) can be programmed independently, at a level different than the magnetic falling switching threshold (B<sub>RP</sub>), and the device internal hysteresis prevents the output from chattering if the application requires B<sub>OP</sub> and B<sub>RP</sub> to be set at the same level—which is the optimized configuration in nominal conditions.

This flexible threshold level programming feature can be exploited to compensate for mechanical misalignment along the Y axis. In the example of Figure 3 where the signal is shifted ahead of phase (the black dotted line named “shifted signal” crosses the 70% threshold before the solid line), moving the B<sub>OP</sub> of the shifted signal “up” to a level around 80% and the B<sub>RP</sub> down to about 60%, brings the digital output edges position back to the same angular position as the original “non-shifted signal”, thus eliminating the mechanical shift. Figure 7 demonstrates how shifting the B<sub>OP</sub> threshold up impacts the electrical output edge position on an Allegro 8X reference target at 1.5 mm air gap.

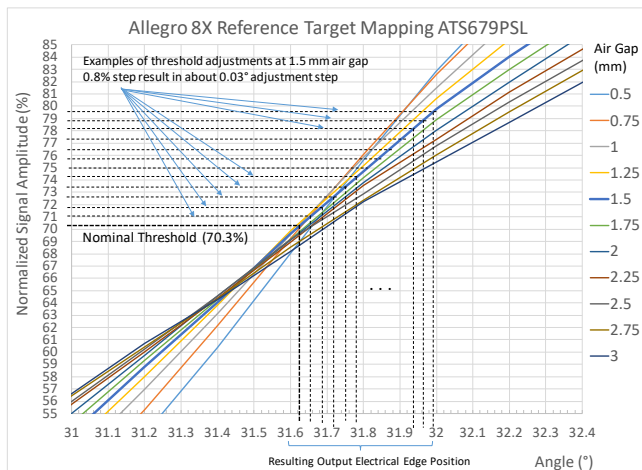

Figure 7: B<sub>OP</sub> adjustment steps of ATS679PSL on Allegro 8X target (B<sub>OP</sub> is magnetic rising slope).

The resolution of compensation, dependent on the threshold programming step size of 0.8% and signal slope, was characterized to be 0.03 degrees per code at 1.5 mm air gap on the Allegro 8X target, for both B<sub>OP</sub> and B<sub>RP</sub>.

The result of this characterization is exhibited in Figure 8.

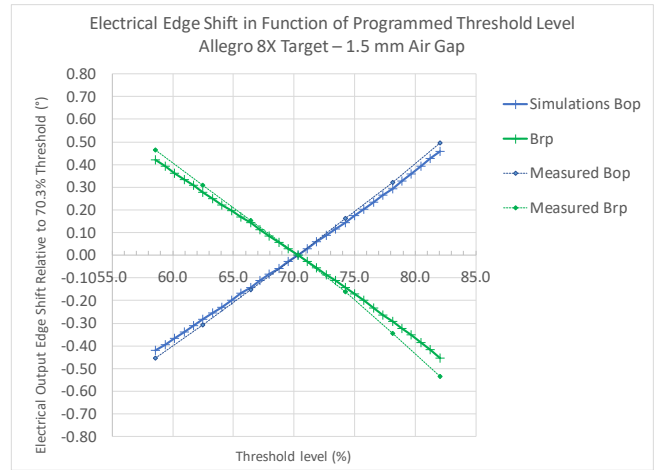

Figure 8: Effect of ATS679PSL threshold adjustment on relative electrical edge position with Allegro 8X target.

To generalize to a use on any target over air gap, the compensation step, in degrees, was simulated over target diameter and air gap. Figure 9 presents the compensation step in function of air gap for several target diameters.

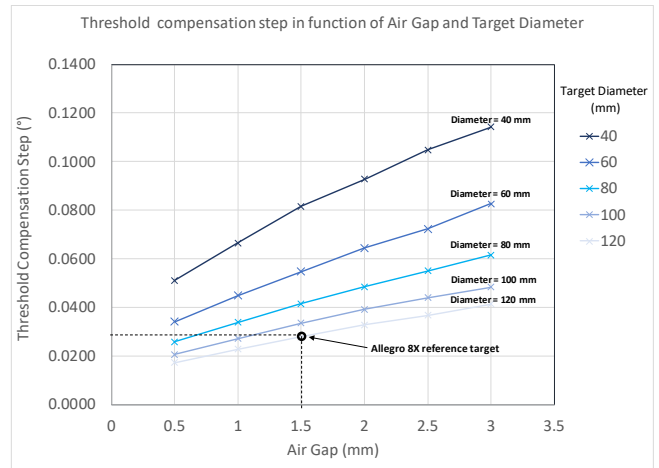

Figure 9: Effect of Air Gap and Target Diameter on ATS679PSL threshold compensation step.

The compensation step could either be characterized on the application target or calculated in function of target diameter and air gap. Equation 2 below provides a good estimation of the compensation step (less accurate on small valleys impacting slope):

$$\epsilon = 3 \times D^{-0.975} - (1.5 - AG) (1.9 \times 10^{-6} \times D^2 - 5 \times 10^{-4} \times D + 0.042) \quad (2)$$

where ε is the threshold adjustment step (°), D is the target diameter (mm), and AG is the air gap (mm).

Practically, applying this compensation method in series production suggests that the finished sensor is 100% tested and compensated individually. A straightforward approach is to mount the finished sensor module at the typical air gap, in front of the target as it would be in the application, compare its electrical edge position to one of a known golden unit, and adjust the threshold level until the electrical edge position of the tested unit is as close as possible to the desired value. To avoid multiple iterations, the threshold could be directly calculated using the compensation step  $\epsilon$  (see Equation 3):

$$Th = (\Delta/\epsilon) + Th_{init} \quad (3)$$

where  $Th$  is the calculated threshold value (LSB),  $Th_{init}$  is the current threshold value (LSB),  $\epsilon$  is the threshold adjustment step ( $^\circ$ ), and  $\Delta$  is the difference between desired edge position and measured electrical output edge position ( $^\circ$ ).

## METHOD FLOWCHART

The threshold adjustment method can be summarized in the following flowchart:

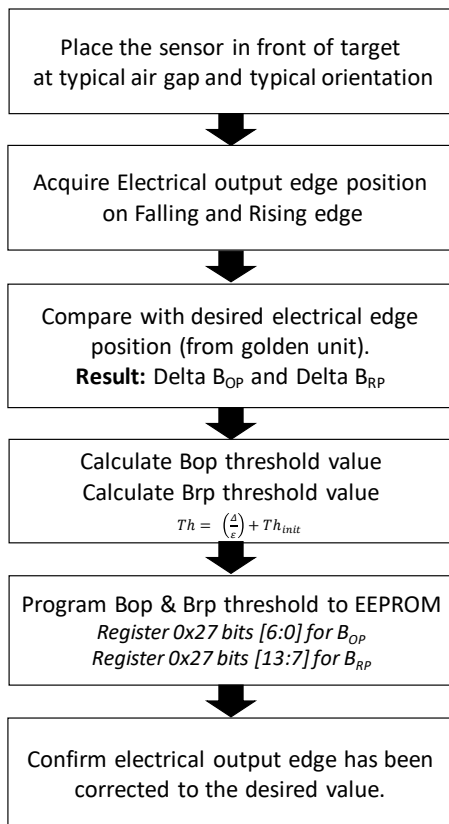

## LIMITATIONS OF THRESHOLD COMPENSATION

### Impact on Air Gap Effect

As seen earlier, if the threshold is moved away from its ideal level (70% with ATS679PSL, 30% from peak), the error over mounting air gap (X axis) will increase and must therefore be taken into consideration. This is illustrated in Figure 10.

Experience has shown that the impact on air gap effect degradation is much smaller than the benefits the threshold compensation method brings. For example, on Allegro 8X reference target, 0.5 mm of misalignment along Y generates  $0.47^\circ$  of error while the air gap effect (over 0.5 to 3.0 mm range) is increased to  $\pm 0.18^\circ$  relative to 1.5 mm typical air gap.

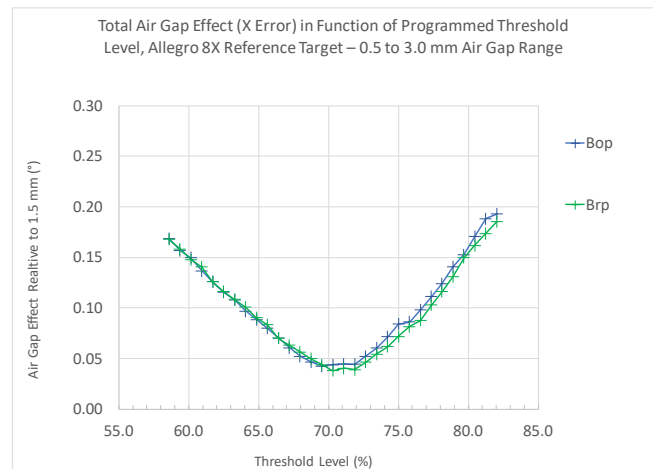

Figure 10: Effect of ATS679PSL threshold change on air gap effect (X error) with Allegro 8X target.

### Impact on Orientation

Applying the threshold compensation method implies that the finished sensor module is mounted on the engine with the same orientation as the one used to correct for the mechanical error, or at least within a limit orientation range. The sensor cannot be twisted around 360 degrees when mounted in the application, because the mechanical error post threshold compensation could be amplified—the worst case being a sensor twisted by 180 degrees post threshold compensation.

This compensation method adds value if the mounting orientation range is less than 90 degrees—the recommended angle is 60 degrees. In such a case, the mechanical tolerance could be compensated by setting the device to an angle equal to the middle of the application orientation range, as shown in Figure 11.



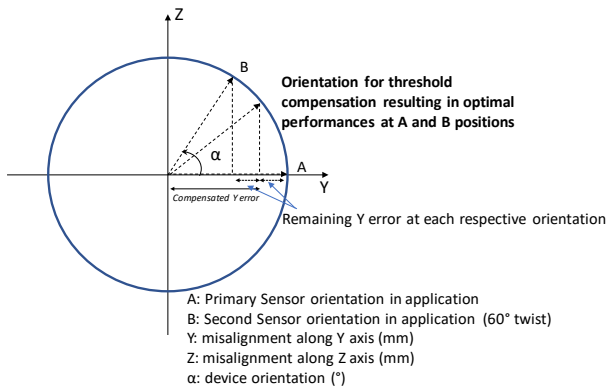

Figure 11: Effect of ATS679PSL orientation on Y axis misalignment.

### Limitation on Runout and Sudden Signal Variation

Runout is the change in air gap over one target revolution due to axial rotation misalignment. It is specified in the datasheet as part of the allowable signal reduction from one peak (tooth) to the next and is dependent on the switching threshold level. For example, if  $B_{OP}$  was set to be 70.3% (29.7% from peak as defined in the datasheet), for full accuracy performances guaranteed, the signal peak change from one tooth to the next one should not be larger than  $B_{OP} - 15\% = 14.7\%$ . If the threshold is set to 20% from peak, the allowable signal variation goes down to 5%.

### EXAMPLE ON ALLEGRO 8X REFERENCE TARGET

As a practical case, a sensor was intentionally shifted along the Y axis by 0.5 mm, generating an electrical edge error measured to 0.47 degrees on an Allegro 8X reference target. The threshold adjustment methodology was followed to calculate the compensating threshold value and program it in the device. The edge position was then remeasured, and the remaining error could be reduced from 0.47 degrees to a value below 0.03°.

This represents 95% of mechanical error reduction. This experiment is summarized in Figure 12.

The benefit is highlighted in the table below:

The effect on air gap effect remains much smaller than the initial misalignment error, as presented in the following table:

Allegro 8X Reference Target	Pre-Compensation Air Gap Effect Relative to 1.5mm [°]		Post-Compensation Air Gap Effect Relative to 1.5mm [°]	
	OP	RP	OP	RP
0.5 to 3.0 mm air gap range	±0.03	±0.08	±0.18	±0.08

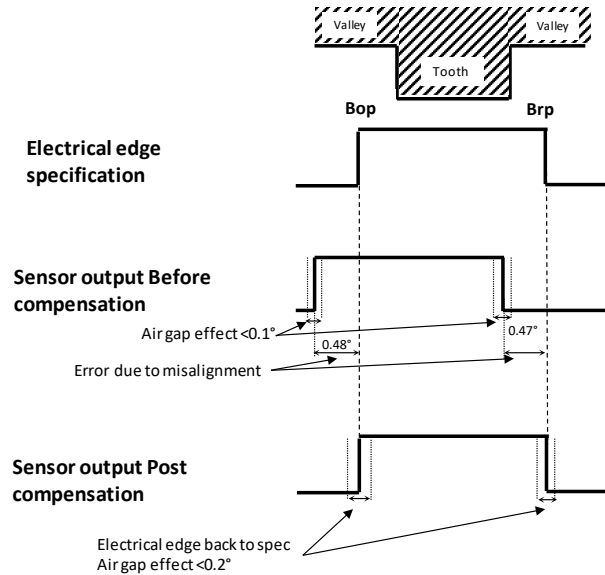

Figure 12: Benefits of threshold compensation method on sensor electrical output.

### CONCLUSION

This application note provides guidelines to compensate for the mechanical error generated during the manufacturing steps of the finished sensor module. This method, involving switching threshold adjustment, shows benefit if the sensor mounting orientation can lie within a limited orientation angle range. Using an example on Allegro 8X reference target, a mechanical error of 0.47° degrees was compensated to a remaining error <0.03°. This represents 95% of mechanical error reduction.

Contact an Allegro representative for any further questions or support.

Allegro 8X Reference target	Δ Error Without Compensation (°)		Th <sub>init</sub> Initial B <sub>OP</sub> /B <sub>RP</sub> Thresholds (70.3% level)(LSB)		Th Calculated B <sub>OP</sub> /B <sub>RP</sub> Thresholds (LSB)		Δ Error Post Compensation (°)		Error Reduction (%)	
	OP	RP	OP	RP	OP	RP	OP	RP	OP	RP
Typical 1.5 mm air gap	-0.48	-0.47	90	90	107	73	-0.021	0.025	96	95

*Revision History*

Number	Date	Description	Responsibility
-	July 10, 2020	Initial release	C. Gillet

Copyright 2020, Allegro MicroSystems.

The information contained in this document does not constitute any representation, warranty, assurance, guaranty, or inducement by Allegro to the customer with respect to the subject matter of this document. The information being provided does not guarantee that a process based on this information will be reliable, or that Allegro has explored all of the possible failure modes. It is the customer's responsibility to do sufficient qualification testing of the final product to insure that it is reliable and meets all design requirements.

Copies of this document are considered uncontrolled documents.