

XtremeSense™ TMR Current Sensor with High dV/dt Immunity, 5 kV Isolation, and Common-Mode Field Rejection

FEATURES AND BENEFITS

- Integrated contact current sensing for low to medium current ranges:
 - 0 to 20 A □ ±30 A □ 0 to 65 A
 - ±20 A □ 0 to 50 A □ ±65 A
 - 0 to 30 A □ ±50 A □ 0 to 70 A
- Optimized for high dV/dt applications
- Integrated current carrying conductor (CCC)
- Linear analog output voltage
- Total error output $\leq \pm 1.0\%$ FS, -40°C to 125°C
- 1 MHz bandwidth
- Response time: ~ 300 ns
- UL/IEC 62368-1 and UL1577 certification
 - Rated isolation voltage: 5 kV_{RMS}
 - Working voltage for basic isolation: $1287\text{ V}_{\text{RMS}}$
 - Working voltage for reinforced isolation: $647\text{ V}_{\text{RMS}}$
- IEC 61000-4-5 certified
- Low noise: 9 to $15\text{ mA}_{\text{RMS}}$ @ $f_{\text{BW}} = 100\text{ kHz}$
- Immunity to common mode fields: -54 dB
- Supply voltage: 4.75 to 5.50 V
- AEC-Q100 grade 1

DESCRIPTION

The CT432 is a high bandwidth and ultra-low noise integrated contact current sensor that uses Allegro patented XtremeSense™ TMR technology to enable high accuracy current measurements for many consumer, enterprise, and industrial applications. The device supports multiple current ranges where the integrated current carrying conductor (CCC) will handle up to 65 A of current and generates a current measurement as a linear analog output voltage. The device achieves a total output error of less than $\pm 1.0\%$ full-scale (FS) over voltage and the full temperature range.

The device has a ~ 300 ns output response time while the current consumption is ~ 6.0 mA and is immune to common mode fields. The CT432 is optimized for high dV/dt applications which minimizes capacitive coupling to V_{OUT} , allowing the CT432 to be used in switching applications.

The CT432 is offered in an industry-standard 16-lead SOIC wide package that is green and RoHS compliant.

APPLICATIONS

- Power inverters
- UPS, SMPS, and telecom power supplies
- Motor control
- Overcurrent fault protection

PACKAGE:



16-lead SOICW

Not to scale



TÜV Certificate No.:
R 72226133 0001



UL Certificate No.:
UL-CA-2201235-0

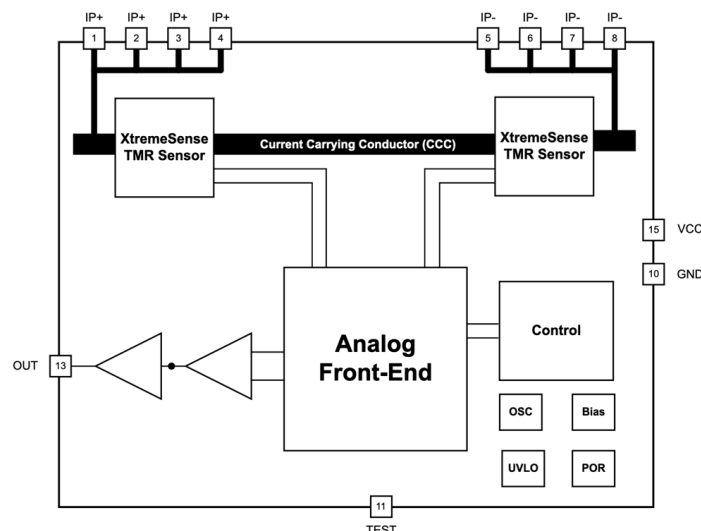

Figure 1: CT432 Functional Block Diagram for 16-lead SOICW Package

CT432

XtremeSense™ TMR Current Sensor with High dV/dt Immunity, 5 kV Isolation, and Common-Mode Field Rejection

SELECTION GUIDE

Part Number	Current Range (I _{PMAX}) (A)	Sensitivity (mV/A)	Operating Temperature Range (°C)	Package	Packing
CT432-HSWF20MR	±20	100	-40 to 125	16-lead SOICW 10.21 mm × 10.31 mm × 2.54 mm	Tape and Reel
CT432-HSWF30MR	±30	66.7			
CT432-HSWF50MR	±50	40			
CT432-HSWF65MR	±65	30.8			
CT432-HSWF20DR	20	200			
CT432-HSWF30DR	30	133.3			
CT432-HSWF50DR	50	80			
CT432-HSWF65DR	65	61.5			
CT432-HSWF70DR	70	57.1			
AEC-Q100 GRADE 1					
CT432-ASWF20MR	±20	100	Grade 1 -40 to 125	16-lead SOICW 10.21 mm × 10.31 mm × 2.54 mm	Tape and Reel
CT432-ASWF30MR	±30	66.7			
CT432-ASWF50MR	±50	40			
CT432-ASWF65MR	±65	30.8			
CT432-ASWF20DR	20	200			
CT432-ASWF30DR	30	133.3			
CT432-ASWF50DR	50	80			
CT432-ASWF65DR	65	61.5			

EVALUATION BOARD SELECTION GUIDE

Part Number	Current Range (A)	Operating Temperature Range (°C)
CTD432-20U	0 to 20	-40 to 125
CTD432-20B	±20	
CTD432-30U	0 to 30	
CTD432-30B	±30	
CTD432-50U	0 to 50	
CTD432-50B	±50	
CTD432-65U	0 to 65	
CTD432-65B	±65	

Table of Contents

Features and Benefits.....	1
Description	1
Applications.....	1
Package	1
Functional Block Diagram	1
Selection Guide	2
Evaluation Board Selection Guide	2
Absolute Maximum Ratings	3
Recommended Operating Conditions	3
Thermal Characteristics	3
Isolation Ratings	4
CMTI Rating	4
Pinout Diagram and Terminal List.....	5
Electrical Characteristics	6
Functional Description	26
Package Outline Drawing.....	30
Tape and Reel Pocket Drawing and Dimensions	31
Package Information.....	32
Device Marking.....	33
Part Ordering Number Legend.....	33
Revision History.....	34

ABSOLUTE MAXIMUM RATINGS [1]

Characteristic	Symbol	Notes	Rating	Unit
Supply Voltage Strength	V_{CC}		-0.3 to 6.0	V
Analog Input/Output Pins Maximum Voltage	$V_{I/O}$		-0.3 to $V_{CC} + 0.3$ [2]	V
Current Carrying Conductor Maximum Current	$I_{CCC(MAX)}$	$T_A = 25^\circ\text{C}$	70	A
Dielectric Surge Strength Test Voltage	V_{SURGE}	IEC 61000-4-5: Tested ± 5 Pulses at 2/60 seconds, 1.2 μs (rise) and 50 μs (width)	6.0 (min)	kV
Surge Strength Test Current	I_{SURGE}	Tested ± 5 Pulses at 3/60 seconds, 8.0 μs (rise) and 20 μs (width)	3.0 (min)	kA
Electrostatic Discharge Protection Level	ESD	Human Body Model (HBM) per JESD22-A114	± 2.0	kV
		Charged Device Model (CDM) per JESD22-C101	± 0.5	kV
Junction Temperature	T_J		-40 to 150	$^\circ\text{C}$
Storage Temperature	T_{STG}		-65 to 155	$^\circ\text{C}$
Lead Soldering Temperature	T_L	10 seconds	260	$^\circ\text{C}$

[1] Stresses exceeding the absolute maximum ratings may damage the CT432 and may not function or be operable above the recommended operating conditions and stressing the parts to these levels is not recommended. In addition, extended exposure to stresses above the recommended operating conditions may affect device reliability. The absolute maximum ratings are stress ratings only.

[2] The lower of $V_{CC} + 0.3$ V or 6.0 V.

RECOMMENDED OPERATING CONDITIONS [1]

Characteristic	Symbol	Notes	Min.	Typ.	Max.	Unit
Supply Voltage Range	V_{CC}		4.75	5.00	5.50	V
Output Voltage Range	V_{OUT}		0	-	V_{CC}	V
Output Current	I_{OUT}		-	-	± 1.0	mA
Operating Ambient Temperature	T_A	Industrial	-40	25	85	$^\circ\text{C}$
		Extended Industrial	-40	25	125	$^\circ\text{C}$
		Automotive	-40	25	125	$^\circ\text{C}$

[1] The Recommended Operating Conditions table defines the conditions for actual operation of the CT432. Recommended operating conditions are specified to ensure optimal performance to the specifications. Allegro does not recommend exceeding them or designing to absolute maximum ratings.

THERMAL CHARACTERISTICS

Characteristic	Symbol	Test Conditions	Value	Unit
Junction-to-Ambient Thermal Resistance	$R_{\theta JA}$	Junction-to-ambient thermal resistance is a function of application and board layout and is determined in accordance to JEDEC standard JESD51 for a four (4) layer 2s2p FR-4 printed circuit board (PCB) with 4 oz. of copper (Cu). Special attention must be paid not to exceed junction temperature $T_{J(MAX)}$ at a given ambient temperature T_A .	15	$^\circ\text{C/W}$
Junction-to-Case Thermal Resistance	$R_{\theta JC}$		10	$^\circ\text{C/W}$

ISOLATION RATINGS

Characteristic	Symbol	Notes	Rating	Unit
Rated Isolation Voltage	V_{ISO}	Agency Tested per IEC 62368 [1] for 60 seconds. Production Tested at V_{ISO} for 1 second per IEC 62368.	5.0	kV _{RMS}
		Agency Tested per UL1577 for 60 seconds. Production Tested at V_{ISO} for 1 second per UL1577.	5.0	kV _{RMS}
Working Voltage for Basic Isolation	V_{WORK_ISO}	Tested per IEC 62368 [1].	1820	V _{PK}
			1287	V _{RMS}
Working Voltage for Reinforced Isolation	V_{WORK_RI}	Tested per IEC 62368 [1].	915	V _{PK}
			647	V _{RMS}
Creepage Distance	D_{CR}	Minimum distance along package body from IP pins to I/O pins.	9.21	mm
Clearance Distance	D_{CL}	Minimum distance through air from IP pins to I/O pins.	8.79	mm
Distance Through Isolation	D_{ISO}	Minimum internal distance through isolation	110	μm
Comparative Tracking Index	CTI	Material Group II	400 to 599	V

[1] IEC 62368 is the succeeding standard to IEC 60950-1 (Edition 2) for isolation testing specifications and as such it will be compliant to the latter standard.

CMTI RATING [1]

Characteristic	Symbol	Test Conditions	Rating	Unit
Common Mode Transient Immunity	CMTI	The failure criterion is that output peak is greater than 100 mV, and duration is longer than 1 μs.	100	kV/μs

[1] Common Mode Transient Immunity defines how the sensor output changes under a high dV/dt event.

PINOUT DIAGRAM AND TERMINAL LIST

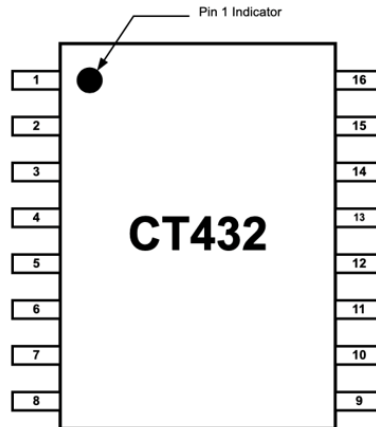

Figure 2: CT432 Pinout Diagram for 16-lead SOICW Package (Top-Down View)

Terminal List

Number	Name	Function
1, 2, 3, 4	IP+	Terminal for primary conductor (positive).
5, 6, 7, 8	IP-	Terminal for primary conductor (negative).
9	NC	No connect.
10	GND	Ground.
11	TEST	Pin used for factory calibration. Connect to Ground.
12	NC	No connect.
13	OUT	Analog output voltage that represents the measured current.
14	NC	No connect.
15	VCC	Supply voltage.
16	NC	No connect.

ELECTRICAL CHARACTERISTICS: Valid for $V_{CC} = 4.75$ to 5.50 V, $C_{BYP} = 1.0$ μ F, and $T_A = -40^\circ\text{C}$ to 125°C , typical values are $V_{CC} = 5.00$ V and $T_A = 25^\circ\text{C}$, unless otherwise specified

Characteristics	Symbol	Test Conditions	Min.	Typ.	Max.	Unit
POWER SUPPLIES						
Supply Current	I_{CC}	$f_{BW} = 1$ MHz, no load, $I_P = 0$ A	–	6.0	9.0	mA
OUT Maximum Drive Capability [1]	I_{OUT}	OUT covers 10% to 90% of V_{CC} span	–1.0	–	+1.0	mA
OUT Capacitive Load [1]	C_{L_OUT}		–	–	100	pF
OUT Resistive Load [1]	R_{L_OUT}		–	100	–	k Ω
Primary Conductor Resistance [1]	R_{IP}		–	0.5	–	m Ω
Power Supply Rejection Ratio [1]	PSRR		–	35	–	dB
Sensitivity Power Supply Rejection Ratio [1]	SPSRR		–	35	–	dB
Offset Power Supply Rejection Ratio [1]	OPSRR		–	40	–	dB
ANALOG OUTPUT (OUT)						
OUT Voltage Linear Range, Typical	V_{OUT}	$V_{SIG_AC} = \pm 2.00$ V, $V_{SIG_DC} = +4.00$ V	0.50	–	4.50	V
Output High Saturation Voltage	V_{OUT_SAT}	V_{OUT} , $T_A = 25^\circ\text{C}$	$V_{CC} - 0.30$	$V_{CC} - 0.25$	–	V
Common Mode Field Rejection Ratio [1]	CMFRR		–	–54	–	dB
			–	0.5	–	mA/G
TIMINGS						
Power-On Time [1]	t_{ON}	$V_{CC} \geq 2.50$ V	–	100	200	μ s
Rise Time [1]	t_{RISE}	$I_P = I_{RANGE(MAX)}$, $T_A = 25^\circ\text{C}$, $C_L = 100$ pF	–	200	–	ns
Response Time [1]	$t_{RESPONSE}$	$I_P = I_{RANGE(MAX)}$, $T_A = 25^\circ\text{C}$, $C_L = 100$ pF	–	300	–	ns
Propagation Delay [1]	t_{DELAY}	$I_P = I_{RANGE(MAX)}$, $T_A = 25^\circ\text{C}$, $C_L = 100$ pF	–	250	–	ns
PROTECTION						
Undervoltage Lockout	V_{UVLO}	Rising V_{DD}	–	2.50	–	V
		Falling V_{DD}	–	2.45	–	V
UVLO Hysteresis	V_{UV_HYS}		–	50	–	mV

[1] Guaranteed by design and characterization; not tested in production.

ELECTRICAL CHARACTERISTICS

$V_{CC} = 5.00\text{ V}$, $T_A = 25^\circ\text{C}$, and $C_{BYP} = 1.0\ \mu\text{F}$ (unless otherwise specified)

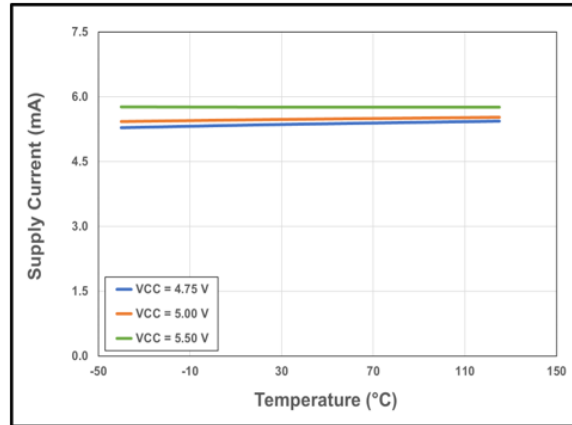

Figure 3: CT432 Supply Current vs. Temperature vs. Supply Voltage

ELECTRICAL CHARACTERISTICS (continued)

$V_{CC} = 5.00\text{ V}$, $T_A = 25^\circ\text{C}$, and $C_{BYP} = 1.0\ \mu\text{F}$ (unless otherwise specified)

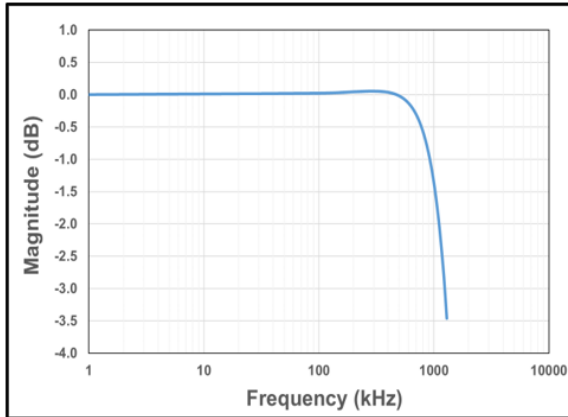

Figure 4: CT432 Bandwidth

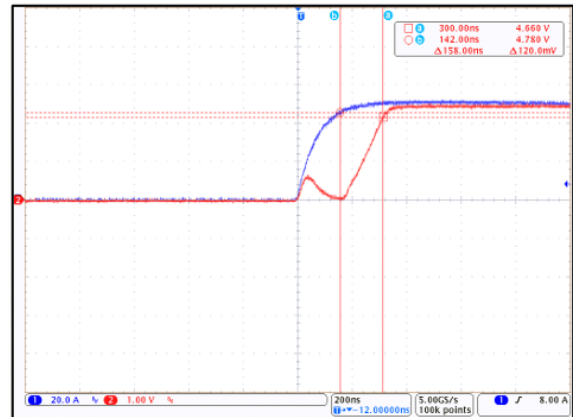

Figure 5: CT432 Response Time; $I_P = 50\text{ A}_{PK}$ and $C_L = 100\text{ pF}$ (Blue = I_{CC} , Red = V_{OUT})

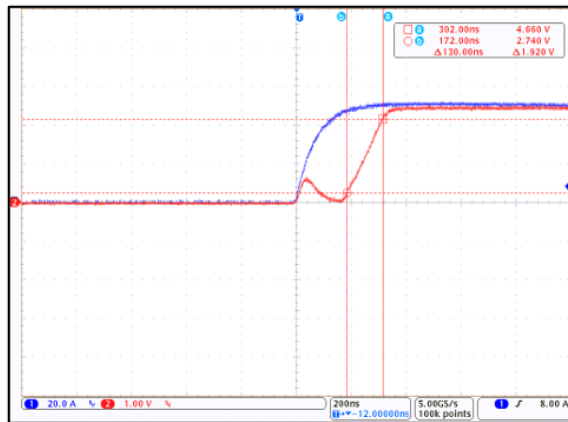

Figure 6: CT432 Rise Time; $I_P = 50\text{ A}_{PK}$ and $C_L = 100\text{ pF}$ (Blue = I_{CC} , Red = V_{OUT})

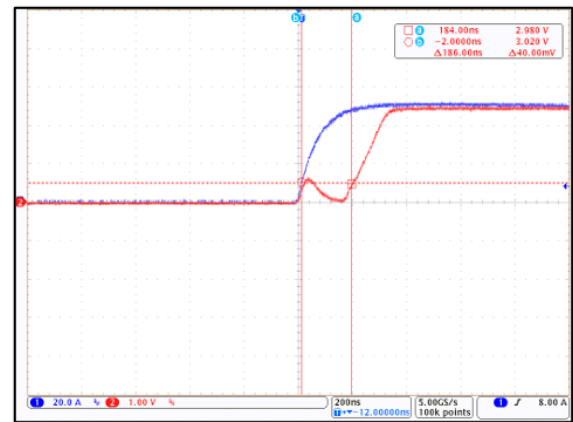

Figure 7: CT432 Propagation Delay; $I_P = 50\text{ A}_{PK}$ and $C_L = 100\text{ pF}$ (Blue = I_{CC} , Red = V_{OUT})

CT432-xSWF20DR: 0 to 20 A – ELECTRICAL CHARACTERISTICS: Valid for $V_{CC} = 4.75$ to 5.50 V, $C_{BYP} = 1.0$ μ F, and $T_A = -40^\circ\text{C}$ to 125°C , typical values are $V_{CC} = 5.00$ V and $T_A = 25^\circ\text{C}$, unless otherwise specified

Characteristics	Symbol	Test Conditions	Min.	Typ.	Max.	Unit
Current Range	I_{RANGE}		0	–	20	A
Voltage Output Quiescent	V_{OQ}	$T_A = 25^\circ\text{C}$, $I_P = 0$ A	0.495	0.500	0.505	V
Sensitivity	S	$I_{RANGE(MIN)} < I_P < I_{RANGE(MAX)}$	–	200	–	mV/A
Bandwidth [1]	f_{BW}	Small Signal = –3 dB	–	1.0	–	MHz
Noise [1]	e_N	$T_A = 25^\circ\text{C}$, $f_{BW} = 100$ kHz	–	9.0	–	mA_{RMS}
OUT ACCURACY PERFORMANCE						
Total Output Error	E_{OUT}	$I_P = I_{P(MAX)}$	–	± 0.7	± 1.0	% FS
Non-Linearity Error [1]	E_{LIN}	$I_P = I_{P(MAX)}$, $T_A = -40^\circ\text{C}$ to 125°C	–	± 0.1	–	% FS
Sensitivity Error [1]	E_{SENS}	$I_P = I_{P(MAX)}$, $T_A = -40^\circ\text{C}$ to 125°C	–	± 0.7	–	% FS
Offset Voltage [1]	V_{OFFSET}	$I_P = 0$ A, $T_A = -40^\circ\text{C}$ to 125°C	–	± 12.5	–	mV
			–	± 0.3	–	% FS
LIFETIME DRIFT						
Total Output Error Lifetime Drift [1]	E_{TOT_DRIFT}	$I_P = I_{P(MAX)}$	–	± 1.0	–	% FS

[1] Guaranteed by design and characterization; not tested in production.

ELECTRICAL CHARACTERISTICS FOR CT432-xSWF20DR

$V_{CC} = 5.00\text{ V}$, $T_A = 25^\circ\text{C}$, and $C_{BYP} = 1.0\ \mu\text{F}$ (unless otherwise specified)

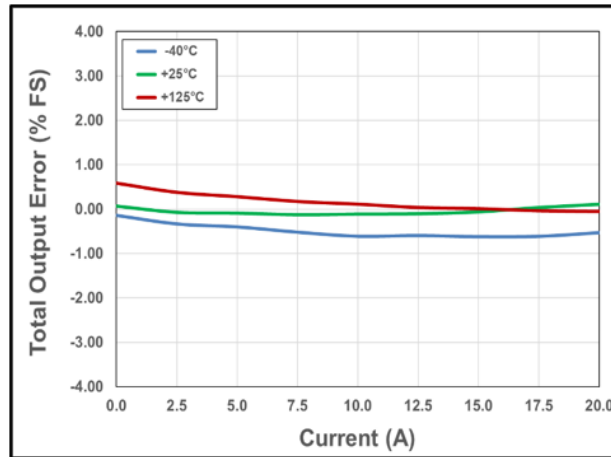

Figure 8: Total Output Error vs. Current vs. Temperature

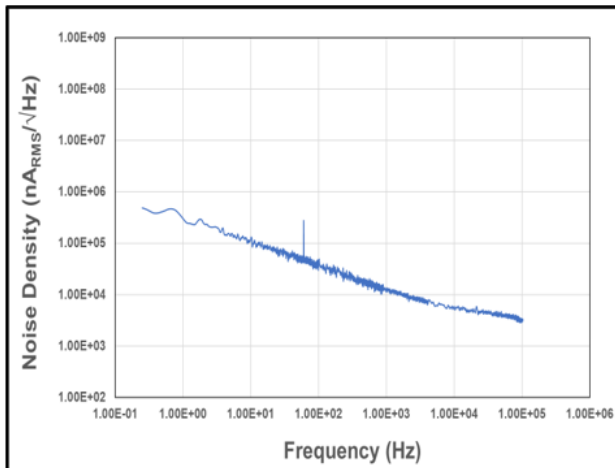

Figure 9: Noise Density vs. Frequency

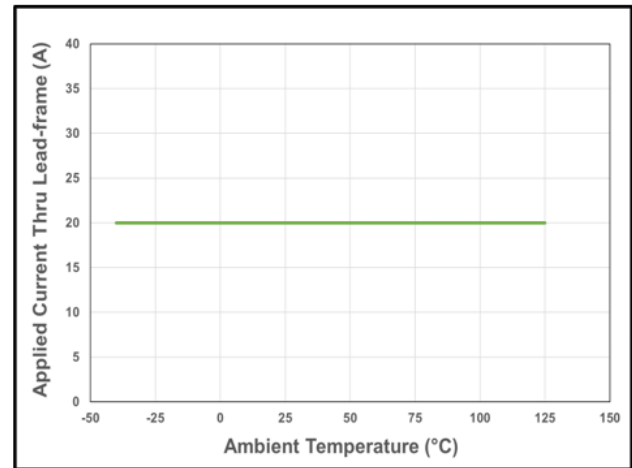

Figure 10: CT432 Current Derating Curve for 20 A_{DC}

CT432-xSWF20MR: ±20 A – ELECTRICAL CHARACTERISTICS: Valid for $V_{CC} = 4.75$ to 5.50 V, $C_{BYP} = 1.0$ μ F, and $T_A = -40^\circ\text{C}$ to 125°C , typical values are $V_{CC} = 5.00$ V and $T_A = 25^\circ\text{C}$, unless otherwise specified

Characteristics	Symbol	Test Conditions	Min.	Typ.	Max.	Unit
Current Range	I_{RANGE}		-20	-	20	A
Voltage Output Quiescent	V_{OQ}	$T_A = 25^\circ\text{C}$, $I_P = 0$ A	2.495	2.500	2.505	V
Sensitivity	S	$I_{RANGE(MIN)} < I_P < I_{RANGE(MAX)}$	-	100	-	mV/A
Bandwidth [1]	f_{BW}	Small Signal = -3 dB	-	1.0	-	MHz
Noise [1]	e_N	$T_A = 25^\circ\text{C}$, $f_{BW} = 100$ kHz	-	10.0	-	mA_{RMS}
OUT ACCURACY PERFORMANCE						
Total Output Error	E_{OUT}	$I_P = I_{P(MAX)}$	-	± 0.5	± 1.0	% FS
Non-Linearity Error [1]	E_{LIN}	$I_P = I_{P(MAX)}$, $T_A = -40^\circ\text{C}$ to 125°C	-	± 0.1	-	% FS
Sensitivity Error [1]	E_{SENS}	$I_P = I_{P(MAX)}$, $T_A = -40^\circ\text{C}$ to 125°C	-	± 0.5	-	% FS
Offset Voltage [1]	V_{OFFSET}	$I_P = 0$ A, $T_A = -40^\circ\text{C}$ to 125°C	-	± 7.0	-	mV
			-	± 0.2	-	% FS
LIFETIME DRIFT						
Total Output Error Lifetime Drift [1]	E_{TOT_DRIFT}	$I_P = I_{P(MAX)}$	-	± 1.0	-	% FS

[1] Guaranteed by design and characterization; not tested in production.

ELECTRICAL CHARACTERISTICS FOR CT432-xSWF20MR

$V_{CC} = 5.00\text{ V}$, $T_A = 25^\circ\text{C}$, and $C_{BYP} = 1.0\ \mu\text{F}$ (unless otherwise specified)

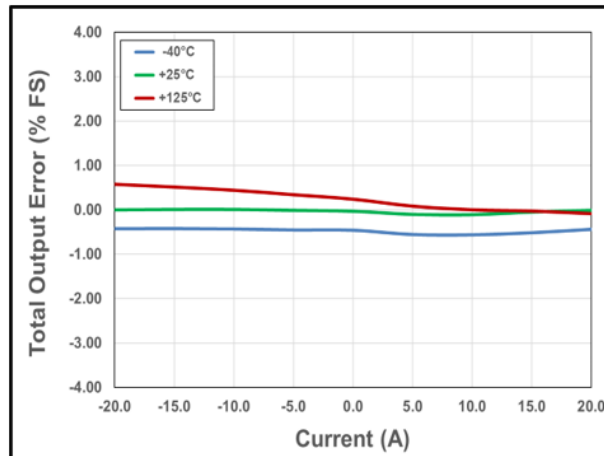

Figure 11: Total Output Error vs. Current vs. Temperature

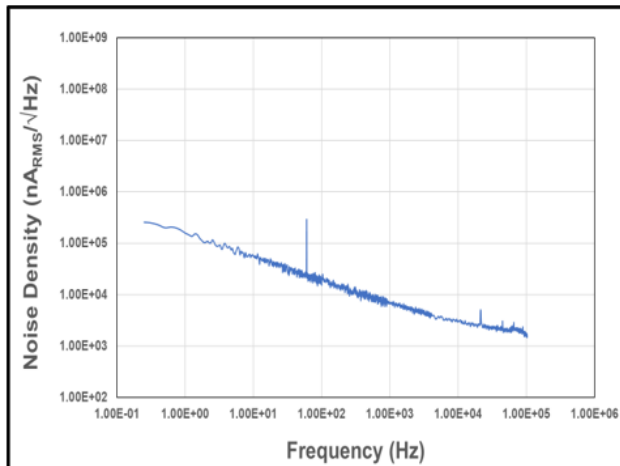

Figure 12: Noise Density vs. Frequency

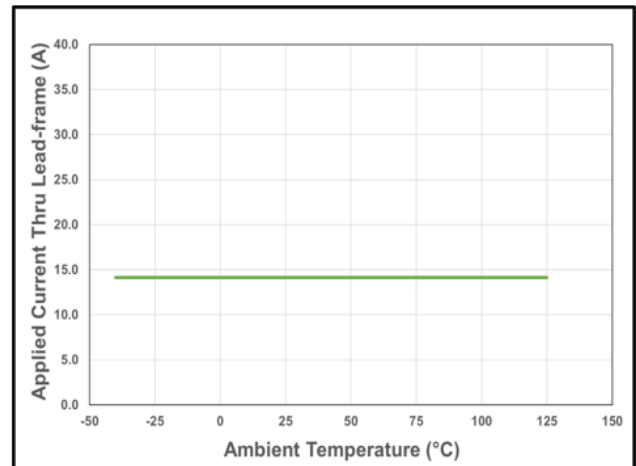

Figure 13: CT432 Current Derating Curve for 20 A_{PK} (14.1 A_{RMS})

CT432-xSWF30DR: 0 to 30 A – ELECTRICAL CHARACTERISTICS: Valid for $V_{CC} = 4.75$ to 5.50 V, $C_{BYP} = 1.0$ μ F, and $T_A = -40^\circ\text{C}$ to 125°C , typical values are $V_{CC} = 5.00$ V and $T_A = 25^\circ\text{C}$, unless otherwise specified

Characteristics	Symbol	Test Conditions	Min.	Typ.	Max.	Unit
Current Range	I_{RANGE}		0	–	30	A
Voltage Output Quiescent	V_{OQ}	$T_A = 25^\circ\text{C}$, $I_P = 0$ A	0.495	0.500	0.505	V
Sensitivity	S	$I_{RANGE(MIN)} < I_P < I_{RANGE(MAX)}$	–	133.3	–	mV/A
Bandwidth [1]	f_{BW}	Small Signal = –3 dB	–	1.0	–	MHz
Noise [1]	e_N	$T_A = 25^\circ\text{C}$, $f_{BW} = 100$ kHz	–	10.0	–	mA_{RMS}
OUT ACCURACY PERFORMANCE						
Total Output Error	E_{OUT}	$I_P = I_{P(MAX)}$	–	± 0.7	± 1.0	% FS
Non-Linearity Error [1]	E_{LIN}	$I_P = I_{P(MAX)}$, $T_A = -40^\circ\text{C}$ to 125°C	–	± 0.1	–	% FS
Sensitivity Error [1]	E_{SENS}	$I_P = I_{P(MAX)}$, $T_A = -40^\circ\text{C}$ to 125°C	–	± 0.6	–	% FS
Offset Voltage [1]	V_{OFFSET}	$I_P = 0$ A, $T_A = -40^\circ\text{C}$ to 125°C	–	± 13.5	–	mV
			–	± 0.3	–	% FS
LIFETIME DRIFT						
Total Output Error Lifetime Drift [1]	E_{TOT_DRIFT}	$I_P = I_{P(MAX)}$	–	± 1.0	–	% FS

[1] Guaranteed by design and characterization; not tested in production.

ELECTRICAL CHARACTERISTICS FOR CT432-xSWF30DR

$V_{CC} = 5.00\text{ V}$, $T_A = 25^\circ\text{C}$, and $C_{BYP} = 1.0\ \mu\text{F}$ (unless otherwise specified)

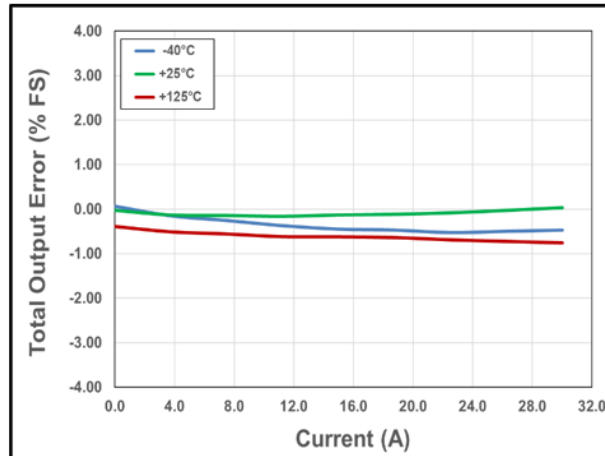

Figure 14: Total Output Error vs. Current vs. Temperature

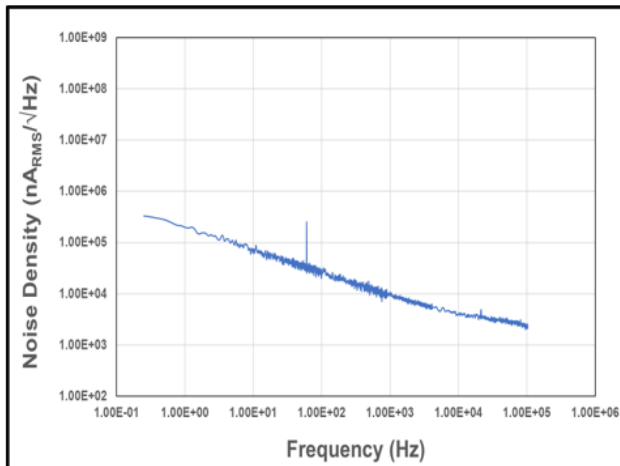

Figure 15: Noise Density vs. Frequency

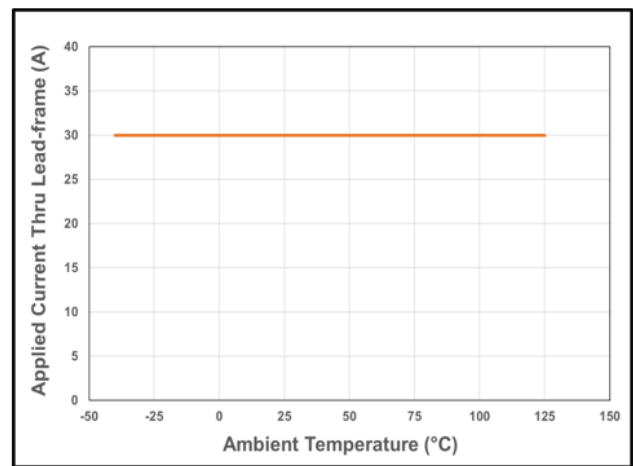

Figure 16: CT432 Current Derating Curve for 30 A_{DC}

CT432-xSWF30MR: ±30 A – ELECTRICAL CHARACTERISTICS: Valid for $V_{CC} = 4.75$ to 5.50 V, $C_{BYP} = 1.0$ μ F, and $T_A = -40^\circ\text{C}$ to 125°C , typical values are $V_{CC} = 5.00$ V and $T_A = 25^\circ\text{C}$, unless otherwise specified

Characteristics	Symbol	Test Conditions	Min.	Typ.	Max.	Unit
Current Range	I_{RANGE}		-30	-	30	A
Voltage Output Quiescent	V_{OQ}	$T_A = 25^\circ\text{C}$, $I_P = 0$ A	2.495	2.500	2.505	V
Sensitivity	S	$I_{RANGE(MIN)} < I_P < I_{RANGE(MAX)}$	-	66.7	-	mV/A
Bandwidth [1]	f_{BW}	Small Signal = -3 dB	-	1.0	-	MHz
Noise [1]	e_N	$T_A = 25^\circ\text{C}$, $f_{BW} = 100$ kHz	-	11.5	-	mA_{RMS}
OUT ACCURACY PERFORMANCE						
Total Output Error	E_{OUT}	$I_P = I_{P(MAX)}$	-	± 0.5	± 1.0	% FS
Non-Linearity Error [1]	E_{LIN}	$I_P = I_{P(MAX)}$, $T_A = -40^\circ\text{C}$ to 125°C	-	± 0.1	-	% FS
Sensitivity Error [1]	E_{SENS}	$I_P = I_{P(MAX)}$, $T_A = -40^\circ\text{C}$ to 125°C	-	± 0.4	-	% FS
Offset Voltage [1]	V_{OFFSET}	$I_P = 0$ A, $T_A = -40^\circ\text{C}$ to 125°C	-	± 9.0	-	mV
			-	± 0.2	-	% FS
LIFETIME DRIFT						
Total Output Error Lifetime Drift [1]	E_{TOT_DRIFT}	$I_P = I_{P(MAX)}$	-	± 1.0	-	% FS

[1] Guaranteed by design and characterization; not tested in production.

ELECTRICAL CHARACTERISTICS FOR CT432-xSWF30MR

$V_{CC} = 5.00\text{ V}$, $T_A = 25^\circ\text{C}$, and $C_{BYP} = 1.0\ \mu\text{F}$ (unless otherwise specified)

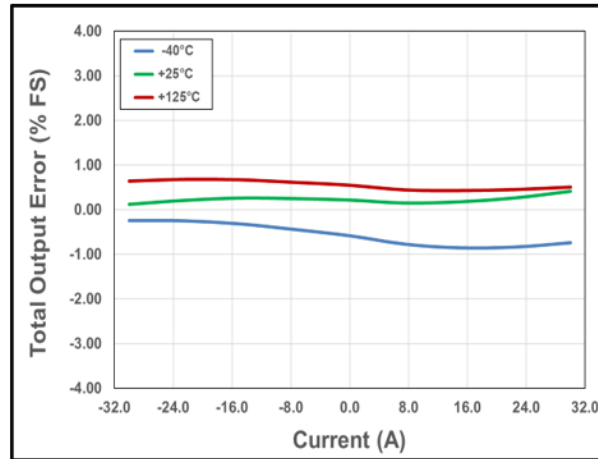

Figure 17: Total Output Error vs. Current vs. Temperature

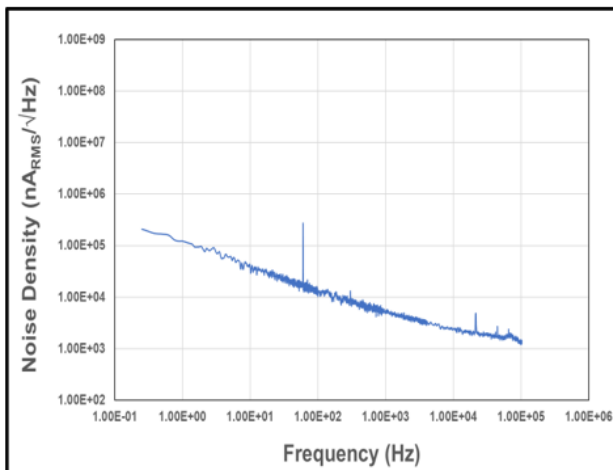

Figure 18: Noise Density vs. Frequency

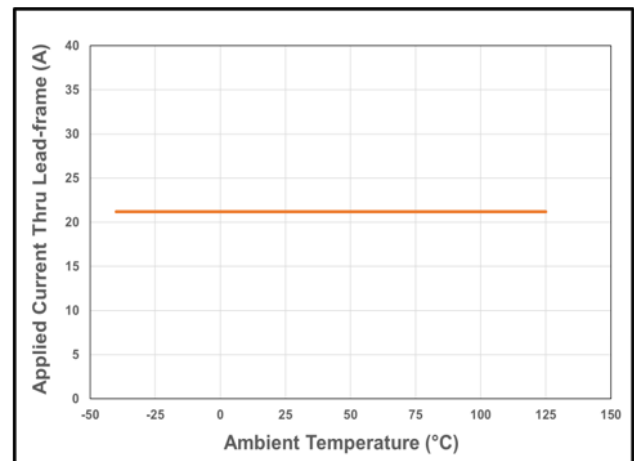

Figure 19: CT432 Current Derating Curve for 30 A_{PK} (21.2 A_{RMS})

CT432-xSWF50DR: 0 to 50 A – ELECTRICAL CHARACTERISTICS: Valid for $V_{CC} = 4.75$ to 5.50 V, $C_{BYP} = 1.0$ μ F, and $T_A = -40^\circ\text{C}$ to 125°C , typical values are $V_{CC} = 5.00$ V and $T_A = 25^\circ\text{C}$, unless otherwise specified

Characteristics	Symbol	Test Conditions	Min.	Typ.	Max.	Unit
Current Range	I_{RANGE}		0	–	50	A
Voltage Output Quiescent	V_{OQ}	$T_A = 25^\circ\text{C}$, $I_P = 0$ A	0.495	0.500	0.505	V
Sensitivity	S	$I_{RANGE(MIN)} < I_P < I_{RANGE(MAX)}$	–	80	–	mV/A
Bandwidth [1]	f_{BW}	Small Signal = –3 dB	–	1.0	–	MHz
Noise [1]	e_N	$T_A = 25^\circ\text{C}$, $f_{BW} = 100$ kHz	–	10.0	–	mA_{RMS}
OUT ACCURACY PERFORMANCE						
Total Output Error	E_{OUT}	$I_P = I_{P(MAX)}$	–	± 0.7	± 1.5	% FS
Non-Linearity Error [1]	E_{LIN}	$I_P = I_{P(MAX)}$, $T_A = -40^\circ\text{C}$ to 125°C	–	± 0.2	–	% FS
Sensitivity Error [1]	E_{SENS}	$I_P = I_{P(MAX)}$, $T_A = -40^\circ\text{C}$ to 125°C	–	± 0.6	–	% FS
Offset Voltage [1]	V_{OFFSET}	$I_P = 0$ A, $T_A = -40^\circ\text{C}$ to 125°C	–	± 12.9	–	mV
			–	± 0.3	–	% FS
LIFETIME DRIFT						
Total Output Error Lifetime Drift [1]	E_{TOT_DRIFT}	$I_P = I_{P(MAX)}$	–	± 1.0	–	% FS

[1] Guaranteed by design and characterization; not tested in production.

ELECTRICAL CHARACTERISTICS FOR CT432-xSWF50DR

$V_{CC} = 5.00\text{ V}$, $T_A = 25^\circ\text{C}$, and $C_{BYP} = 1.0\ \mu\text{F}$ (unless otherwise specified)

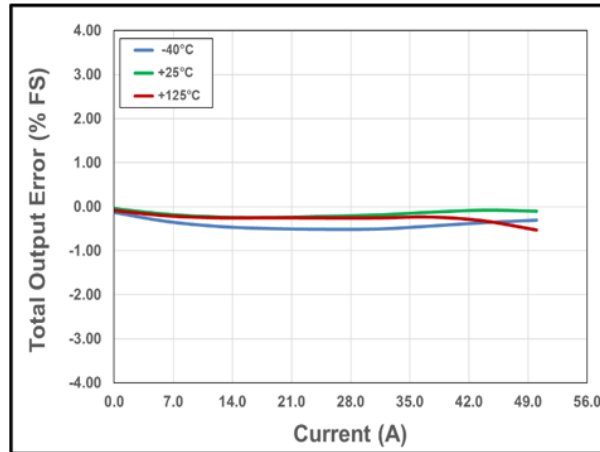

Figure 20: Total Output Error vs. Current vs. Temperature

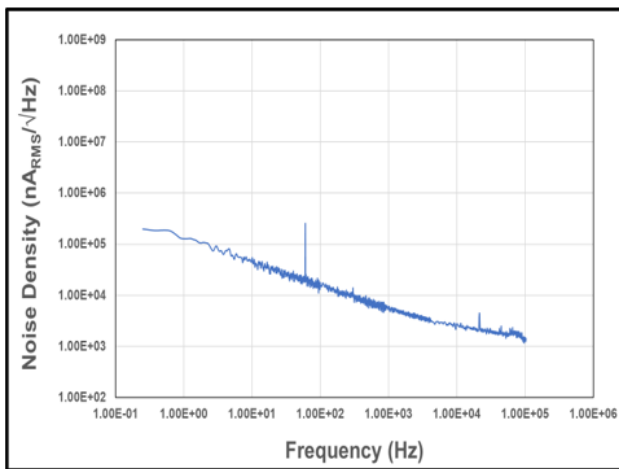

Figure 21: Noise Density vs. Frequency

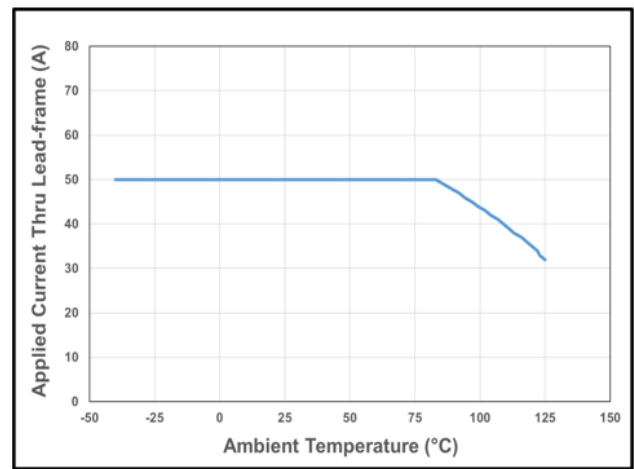

Figure 22: CT432 Current Derating Curve for 50 A_{DC}

CT432-xSWF50MR: ±50 A – ELECTRICAL CHARACTERISTICS: Valid for $V_{CC} = 4.75$ to 5.50 V, $C_{BYP} = 1.0$ μ F, and $T_A = -40^\circ\text{C}$ to 125°C , typical values are $V_{CC} = 5.00$ V and $T_A = 25^\circ\text{C}$, unless otherwise specified

Characteristics	Symbol	Test Conditions	Min.	Typ.	Max.	Unit
Current Range	I_{RANGE}		-50	-	50	A
Voltage Output Quiescent	V_{OQ}	$T_A = 25^\circ\text{C}$, $I_P = 0$ A	2.495	2.500	2.505	V
Sensitivity	S	$I_{RANGE(MIN)} < I_P < I_{RANGE(MAX)}$	-	40	-	mV/A
Bandwidth [1]	f_{BW}	Small Signal = -3 dB	-	1.0	-	MHz
Noise [1]	e_N	$T_A = 25^\circ\text{C}$, $f_{BW} = 100$ kHz	-	14.0	-	mA_{RMS}
OUT ACCURACY PERFORMANCE						
Total Output Error	E_{OUT}	$I_P = I_{P(MAX)}$	-	± 0.5	± 1.0	% FS
Non-Linearity Error [1]	E_{LIN}	$I_P = I_{P(MAX)}$, $T_A = -40^\circ\text{C}$ to 125°C	-	± 0.1	-	% FS
Sensitivity Error [1]	E_{SENS}	$I_P = I_{P(MAX)}$, $T_A = -40^\circ\text{C}$ to 125°C	-	± 0.5	-	% FS
Offset Voltage [1]	V_{OFFSET}	$I_P = 0$ A, $T_A = -40^\circ\text{C}$ to 125°C	-	± 10.9	-	mV
			-	± 0.3	-	% FS
LIFETIME DRIFT						
Total Output Error Lifetime Drift [1]	E_{TOT_DRIFT}	$I_P = I_{P(MAX)}$	-	± 1.0	-	% FS

[1] Guaranteed by design and characterization; not tested in production.

ELECTRICAL CHARACTERISTICS FOR CT432-xSWF50MR

$V_{CC} = 5.00\text{ V}$, $T_A = 25^\circ\text{C}$, and $C_{BYP} = 1.0\ \mu\text{F}$ (unless otherwise specified)

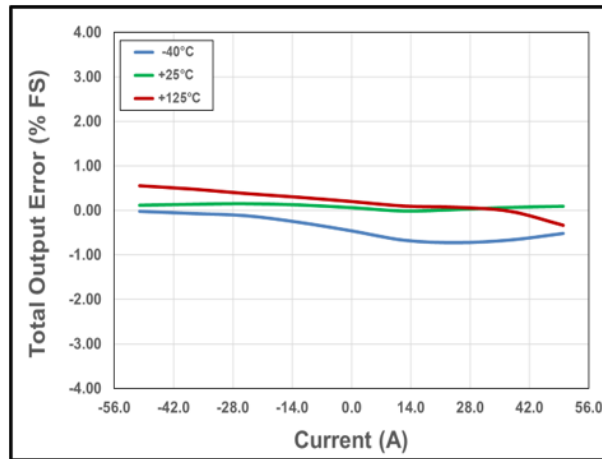

Figure 23: Total Output Error vs. Current vs. Temperature

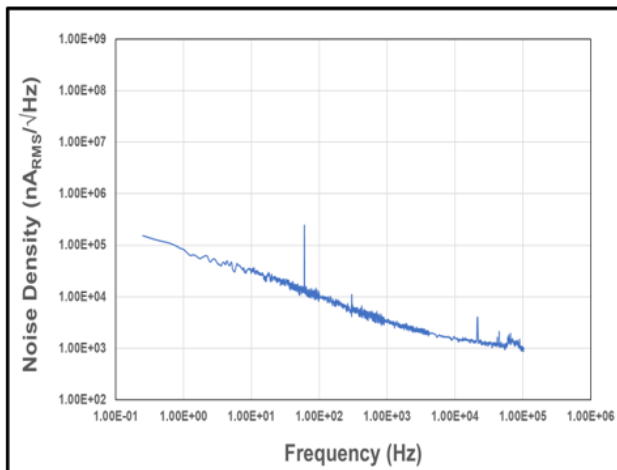

Figure 24: Noise Density vs. Frequency

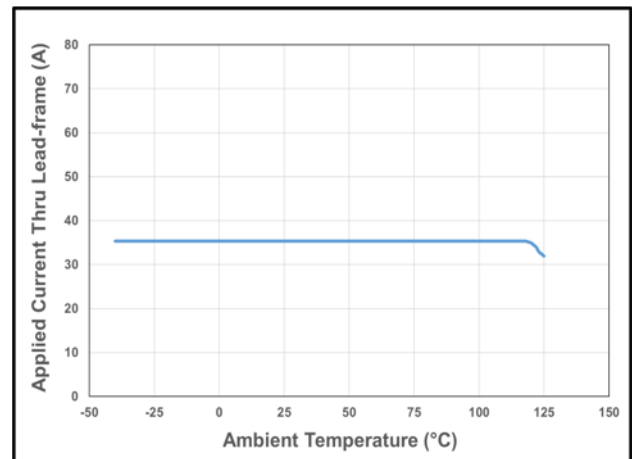

Figure 25: CT432 Current Derating Curve for 50 A_{PK} (35.5 A_{RMS})

CT432-xSWF65DR: 0 to 65 A – ELECTRICAL CHARACTERISTICS: Valid for $V_{CC} = 4.75$ to 5.50 V, $C_{BYP} = 1.0$ μ F, and $T_A = -40^\circ\text{C}$ to 125°C , typical values are $V_{CC} = 5.00$ V and $T_A = 25^\circ\text{C}$, unless otherwise specified

Characteristics	Symbol	Test Conditions	Min.	Typ.	Max.	Unit
Current Range	I_{RANGE}		0	–	65	A
Voltage Output Quiescent	V_{OQ}	$T_A = 25^\circ\text{C}$, $I_P = 0$ A	0.495	0.500	0.505	V
Sensitivity	S	$I_{RANGE(MIN)} < I_P < I_{RANGE(MAX)}$	–	61.5	–	mV/A
Bandwidth [1]	f_{BW}	Small Signal = –3 dB	–	1.0	–	MHz
Noise [1]	e_N	$T_A = 25^\circ\text{C}$, $f_{BW} = 100$ kHz	–	10.0	–	mA_{RMS}
OUT ACCURACY PERFORMANCE						
Total Output Error	E_{OUT}	$I_P = I_{P(MAX)}$	–	± 0.7	± 1.5	% FS
Non-Linearity Error [1]	E_{LIN}	$I_P = I_{P(MAX)}$, $T_A = -40^\circ\text{C}$ to 125°C	–	± 0.2	–	% FS
Sensitivity Error [1]	E_{SENS}	$I_P = I_{P(MAX)}$, $T_A = -40^\circ\text{C}$ to 125°C	–	± 0.4	–	% FS
Offset Voltage [1]	V_{OFFSET}	$I_P = 0$ A, $T_A = -40^\circ\text{C}$ to 125°C	–	± 3.0	–	mV
			–	± 0.1	–	% FS
LIFETIME DRIFT						
Total Output Error Lifetime Drift [1]	E_{TOT_DRIFT}	$I_P = I_{P(MAX)}$	–	± 1.0	–	% FS

[1] Guaranteed by design and characterization; not tested in production.

ELECTRICAL CHARACTERISTICS FOR CT432-xSWF65DR

$V_{CC} = 5.00\text{ V}$, $T_A = 25^\circ\text{C}$, and $C_{BYP} = 1.0\ \mu\text{F}$ (unless otherwise specified)

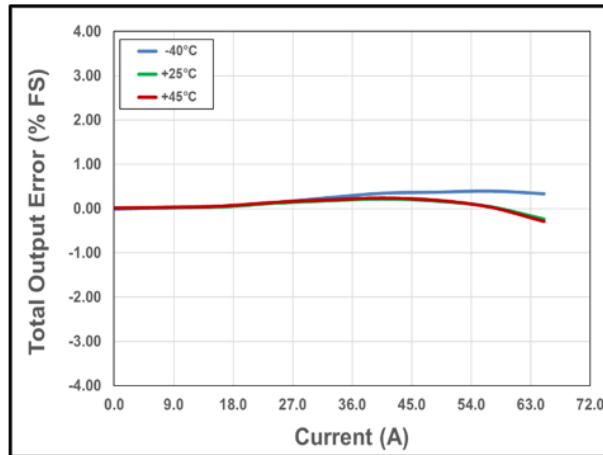

Figure 26: Total Output Error vs. Current vs. Temperature

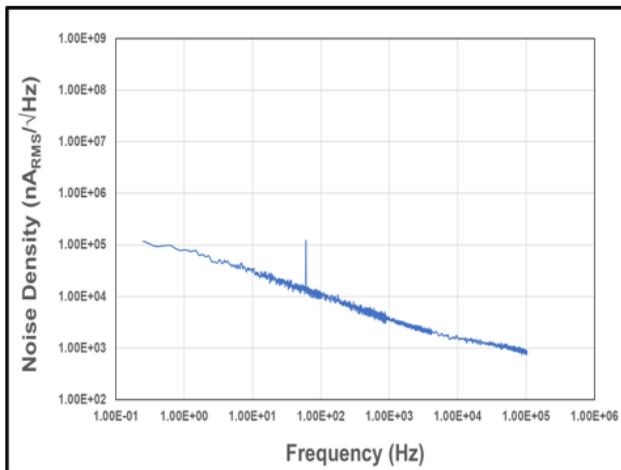

Figure 27: Noise Density vs. Frequency

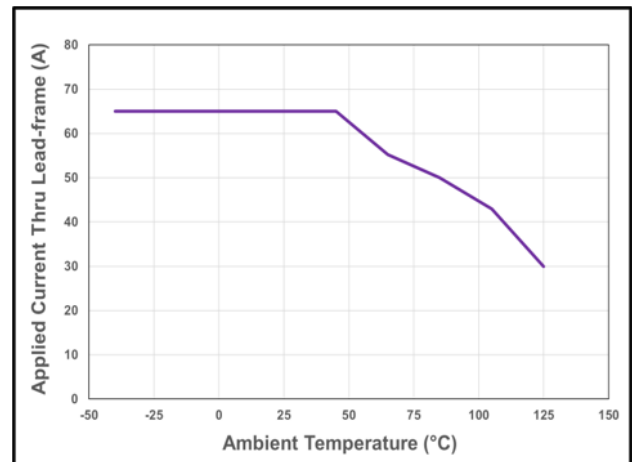

Figure 28: CT432 Current Derating Curve for 65 A_{DC}

CT432-xSWF65MR: ±65 A – ELECTRICAL CHARACTERISTICS: Valid for $V_{CC} = 4.75$ to 5.50 V, $C_{BYP} = 1.0$ μ F, and $T_A = -40^\circ\text{C}$ to 125°C , typical values are $V_{CC} = 5.00$ V and $T_A = 25^\circ\text{C}$, unless otherwise specified

Characteristics	Symbol	Test Conditions	Min.	Typ.	Max.	Unit
Current Range	I_{RANGE}		-65	-	65	A
Voltage Output Quiescent	V_{OQ}	$T_A = 25^\circ\text{C}$, $I_P = 0$ A	2.495	2.500	2.505	V
Sensitivity	S	$I_{RANGE(MIN)} < I_P < I_{RANGE(MAX)}$	-	30.8	-	mV/A
Bandwidth [1]	f_{BW}	Small Signal = -3 dB	-	1.0	-	MHz
Noise [1]	e_N	$T_A = 25^\circ\text{C}$, $f_{BW} = 100$ kHz	-	13.5	-	mA_{RMS}
OUT ACCURACY PERFORMANCE						
Total Output Error	E_{OUT}	$I_P = I_{P(MAX)}$	-	± 0.5	± 1.0	% FS
Non-Linearity Error [1]	E_{LIN}	$I_P = I_{P(MAX)}$, $T_A = -40^\circ\text{C}$ to 125°C	-	± 0.2	-	% FS
Sensitivity Error [1]	E_{SENS}	$I_P = I_{P(MAX)}$, $T_A = -40^\circ\text{C}$ to 125°C	-	± 0.3	-	% FS
Offset Voltage [1]	V_{OFFSET}	$I_P = 0$ A, $T_A = -40^\circ\text{C}$ to 125°C	-	± 3.0	-	mV
			-	± 0.1	-	% FS
LIFETIME DRIFT						
Total Output Error Lifetime Drift [1]	E_{TOT_DRIFT}	$I_P = I_{P(MAX)}$	-	± 1.0	-	% FS

[1] Guaranteed by design and characterization; not tested in production.

ELECTRICAL CHARACTERISTICS FOR CT432-xSWF65MR

$V_{CC} = 5.00\text{ V}$, $T_A = 25^\circ\text{C}$, and $C_{BYP} = 1.0\ \mu\text{F}$ (unless otherwise specified)

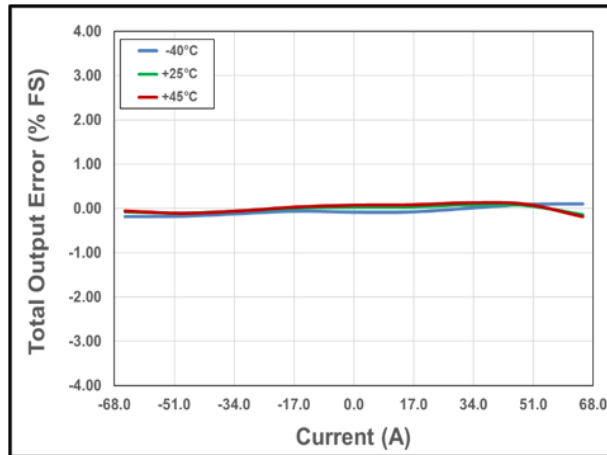

Figure 29: Total Output Error vs. Current vs. Temperature

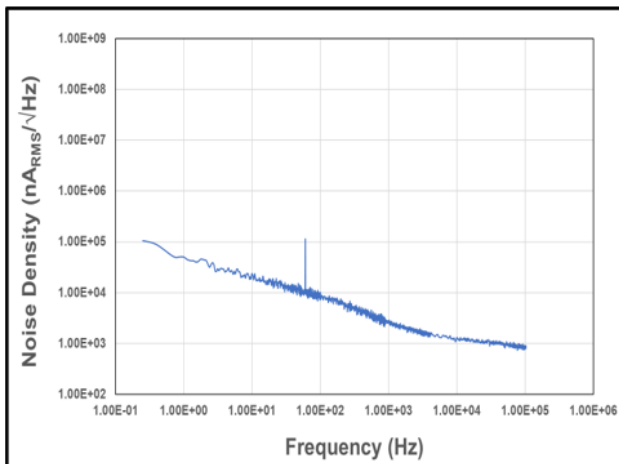

Figure 30: Noise Density vs. Frequency

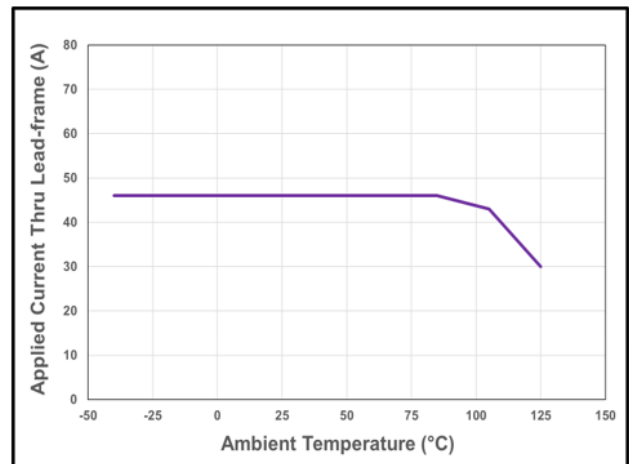

Figure 31: CT432 Current Derating Curve for 65 A_{PK} (46.0 A_{RMS})

CT432-xSWF70DR: 0 to 70 A – ELECTRICAL CHARACTERISTICS: Valid for $V_{CC} = 4.75$ to 5.50 V, $C_{BYP} = 1.0$ μ F, and $T_A = -40^\circ\text{C}$ to 125°C , typical values are $V_{CC} = 5.00$ V and $T_A = 25^\circ\text{C}$, unless otherwise specified

Characteristics	Symbol	Test Conditions	Min.	Typ.	Max.	Unit
Current Range	I_{RANGE}		-70	-	70	A
Voltage Output Quiescent	V_{OQ}	$T_A = 25^\circ\text{C}$, $I_P = 0$ A	0.495	0.500	0.505	V
Sensitivity	S	$I_{RANGE(MIN)} < I_P < I_{RANGE(MAX)}$	-	57.1	-	mV/A
Bandwidth [1]	f_{BW}	Small Signal = -3 dB	-	1.0	-	MHz
Noise [1]	e_N	$T_A = 25^\circ\text{C}$, $f_{BW} = 100$ kHz	-	10.0	-	mA_{RMS}
OUT ACCURACY PERFORMANCE						
Total Output Error	E_{OUT}	$I_P = I_{P(MAX)}$	-	± 0.7	± 1.5	% FS
Non-Linearity Error [1]	E_{LIN}	$I_P = I_{P(MAX)}$, $T_A = -40^\circ\text{C}$ to 125°C	-	± 0.2	-	% FS
Sensitivity Error [1]	E_{SENS}	$I_P = I_{P(MAX)}$, $T_A = -40^\circ\text{C}$ to 125°C	-	± 0.4	-	% FS
Offset Voltage [1]	V_{OFFSET}	$I_P = 0$ A, $T_A = -40^\circ\text{C}$ to 125°C	-	± 3.0	-	mV
			-	± 0.1	-	% FS
LIFETIME DRIFT						
Total Output Error Lifetime Drift [1]	E_{TOT_DRIFT}	$I_P = I_{P(MAX)}$	-	± 1.0	-	% FS

[1] Guaranteed by design and characterization; not tested in production.

ELECTRICAL CHARACTERISTICS FOR CT432-xSWF70DR

$V_{CC} = 5.00$ V, $T_A = 25^\circ\text{C}$, and $C_{BYP} = 1.0$ μ F (unless otherwise specified)

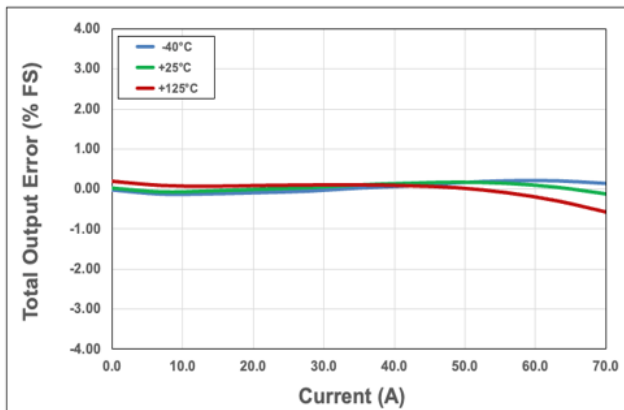

Figure 32: Total Output Error vs. Current vs. Temperature

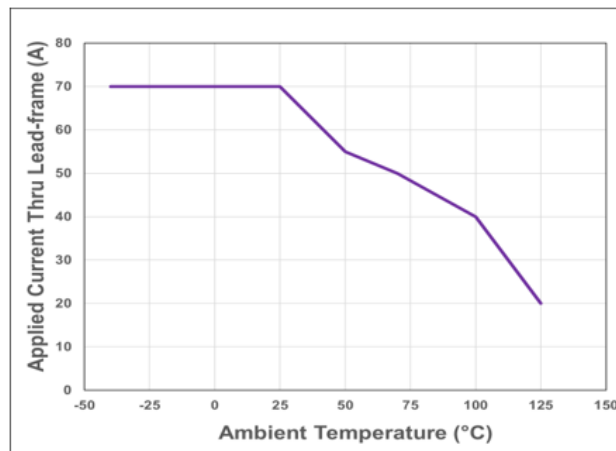

Figure 33: CT432 Current Derating Curve for 70 A_{RMS}

FUNCTIONAL DESCRIPTION

Overview

The CT432 is a high accuracy contact current sensor with an integrated current-carrying conductor that handles up to 65 A. It has high sensitivity and a wide dynamic range with excellent accuracy (low total output error) across temperature. This current sensor supports nine current ranges:

- 0 to 20 A
- ±30 A
- 0 to 65 A
- ±20 A
- 0 to 50 A
- ±65 A
- 0 to 30 A
- ±50 A
- 0 to 70 A

When current is flowing through the current-carrying conductor, the XtremeSense TMR sensors inside the chip senses the field which in turn generates differential voltage signals that then goes through the Analog Front-End (AFE) to output a current measurement with less than ±1.0% full-scale total output error (E_{OUT}).

The chip is designed to enable a fast response time of 300 ns for the current measurement from the OUT pin as the bandwidth for the CT432 is 1.0 MHz. Even with a high bandwidth, the chip consumes a minimal amount of power.

Linear Output Current Measurement

The CT432 provides a continuous linear analog output voltage which represents the current measurement. The output voltage range of OUT is from 0.50 to 4.50 V with a V_{OQ} of 0.50 V and 2.50 V for unidirectional and bidirectional currents, respectively. Figure 34 illustrates the output voltage range of the OUT pin as a function of the measured current.

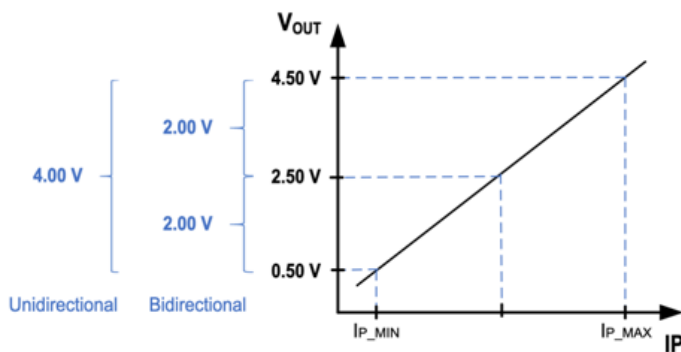

Figure 34: Linear Output Voltage Range (OUT) vs. Measured Current (IP)

Total Output Error

The Total Output Error (E_{OUT}) is the maximum deviation of the sensor output from the ideal sensor transfer curve over the full temperature range relative to the sensor full scale.

The Total Output Error is measured by performing a full-scale primary current (IP) sweep and measuring V_{OUT} at multiple points.

$$E_{OUT} = 100 * \frac{\max(V_{OUT_{IDEAL}}(I) - V_{OUT}(I))}{F.S.}$$

The Ideal Transfer Curve is calculated based on datasheet parameters as described below.

$$V_{OUT_{IDEAL}}(I_P) = V_{OQ} + S * I_P$$

E_{OUT} incorporates all sources of error and is a function of the sensed current (I_P) from the current sensor.

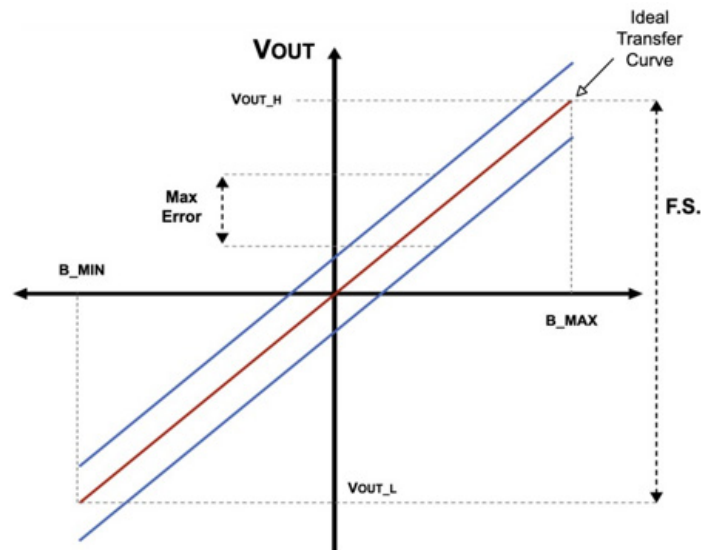

Figure 35: Total Output Error (E_{OUT}) vs. Sensed Current (I_P)

The CT432 achieves a total output error (E_{OUT}) that is less than ±1.0% of Full-Scale (FS) over supply voltage and temperature. It is designed with innovative and proprietary TMR sensors and circuit blocks to provide very accurate current measurements regardless of the operating conditions.

Sensitivity Error

The sensitivity error (E_{SENS}) is the sensitivity temperature drift error for unipolar or DC current. It is calculated using the equation below:

$$E_{SENS} = 100 \times \left(\frac{S_{MEASURED}}{S} - 1 \right)$$

Power-On Time (t_{ON})

Power-On Time (t_{ON}) of 100 μ s is the amount of time required by CT432 to start up, fully power the chip, and becoming fully operational from the moment the supply voltage is greater than the UVLO voltage. This time includes the ramp-up time and the settling time (within 10% of steady-state voltage under an applied magnetic field) after the power supply has reached the minimum V_{CC} .

Response Time ($t_{RESPONSE}$)

Response Time ($t_{RESPONSE}$) of 300 ns for the CT432 is the time interval between the following terms:

1. When the primary current signal reaches 90% of its final value,
2. When the chip reaches 90% of its output corresponding to the applied current.

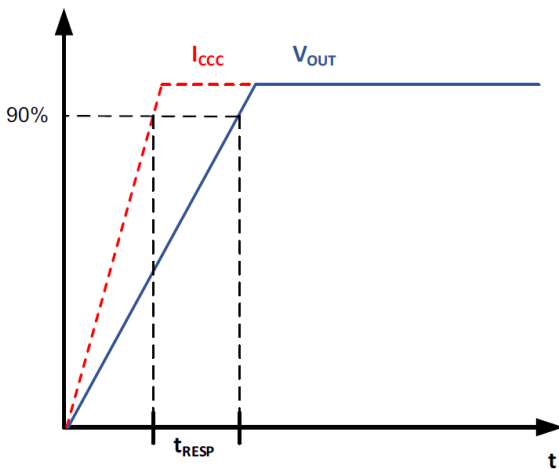

Figure 36: CT432 Response Time Curve

Rise Time (t_{RISE})

Rise Time (t_{RISE}) is the time interval of when it reaches 10% and 90% of the full-scale output voltage. The t_{RISE} of the CT432 is 200 ns.

Propagation Delay (t_{DELAY})

Propagation Delay (t_{DELAY}) is the time difference between these two events:

1. When the primary current reaches 20% of its final value
2. When the chip reaches 20% of its output corresponding to the applied current.

The CT432 has a propagation delay of 250 ns.

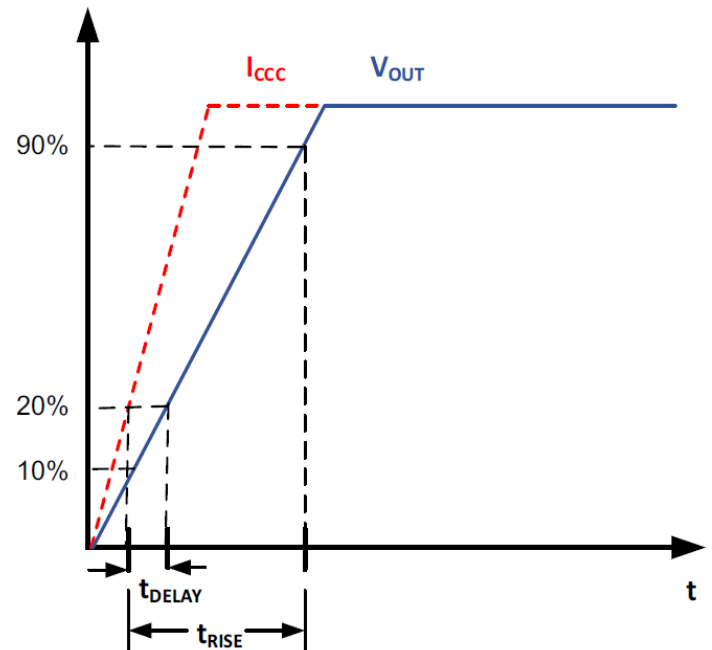

Figure 37: CT432 Propagation Delay and Rise Time Curve

Undervoltage Lockout (UVLO)

The Undervoltage Lockout protection circuitry of the CT432 is activated when the supply voltage (V_{CC}) falls below 2.45 V. The CT432 remains in a low quiescent state until V_{CC} rises above the UVLO threshold (2.50 V). In this condition where V_{CC} is less than 2.45 V and UVLO is triggered, the output from the CT432 is not valid. Once V_{CC} rises above 2.50 V then the UVLO is cleared.

Immunity to Common Mode Fields

The CT432 is housed in custom plastic package that uses a U-shaped leadframe to reduce the common mode fields generated by external stray magnetic fields. With the U-shaped leadframe, the stray fields cancel one another thus reducing electro-magnetic interference (EMI). The CT432 is able to achieve -54 dB of

Common Mode Rejection Ratio (CMFRR). Also, good PCB layout of the CT432 will optimize performance and reduce EMI.

Creepage and Clearance

Two important terms as it relates to isolation provided by the package are: creepage and clearance. Creepage is defined as the shortest distance across the surface of the package from one side the leads to the other side of the leads. The definition for clearance is the shortest distance between the leads of opposite side through the air. Figure 38 illustrates the creepage and clearance for the SOICW-16 package of the CT432.

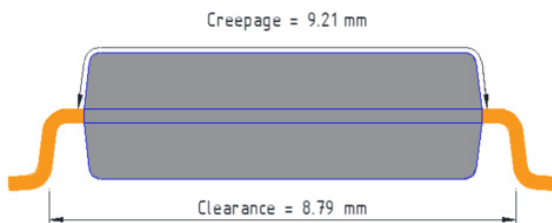

Figure 38: The Creepage and Clearance for the CT432 SOICW-16 package

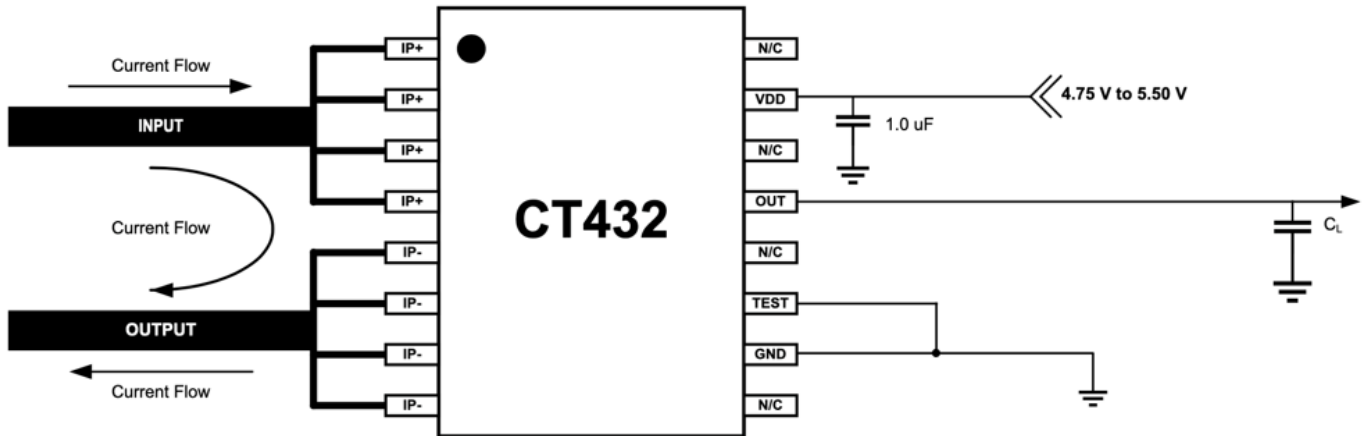

Figure 39: CT432 Application Block Diagram

Application

The CT432 is an integrated contact current sensor that can be used in many applications from measuring current in power supplies to motor control to overcurrent fault protection. It is a plug-and-play solution in that no calibration is required, and it can output to a microcontroller a simple linear analog output voltage which corresponds to a current measurement value. Figure 39 is an application diagram of how CT432 would be implemented in a system.

The device is designed to support an operating voltage range of 4.75 V to 5.50 V, but it is ideal to use a 5.0 V power supply where the output tolerance is less than $\pm 5\%$.

Bypass Capacitor

A single 1.0 μF capacitor is needed for the VCC pin to reduce the noise from the power supply and other circuits. This capacitor should be placed as close as possible to the CT432 to minimize inductance and resistance between the two devices.

Fuse Time vs. Current

Since the CT432 is a contact current sensor, it dissipates heat as current is conducted through its leadframe. The CT432 leadframe has 0.5 m Ω resistance (typ) which results in low power dissipation during normal operation.

However, when the current surges above the rated nominal values of the CT432 due to short circuit or transient current spikes for

a specific duration of time, the leadframe will be permanently damaged.

Figure 40 illustrates the CT432 fuse time for 100 A, 200 A, and 300 A current levels. The CT432 tolerates 100 A for 32 seconds, while at 200 A and 300 A, the fuse times are 194 ms and 45 ms, respectively.

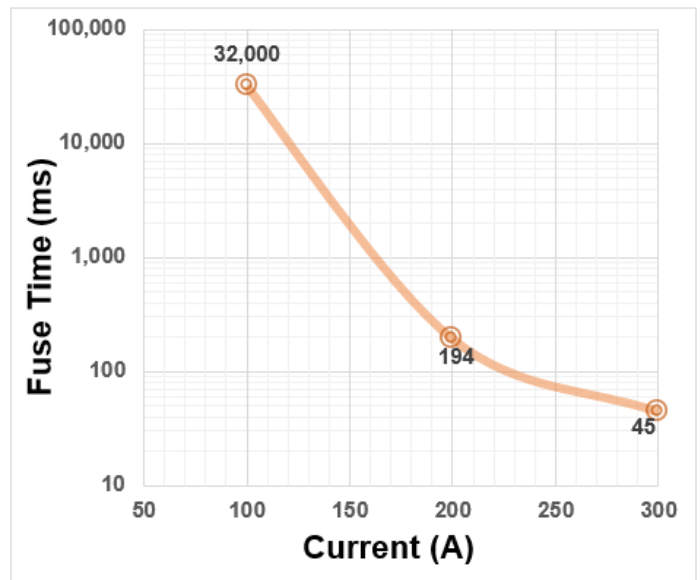

Figure 40: CT432 Fuse Time vs. Current

PACKAGE OUTLINE DRAWING

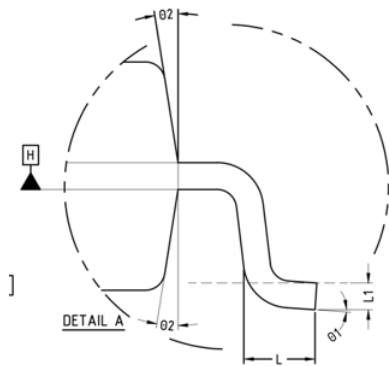
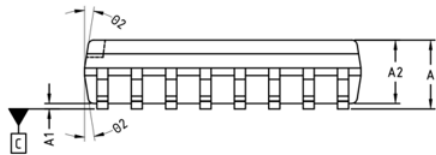
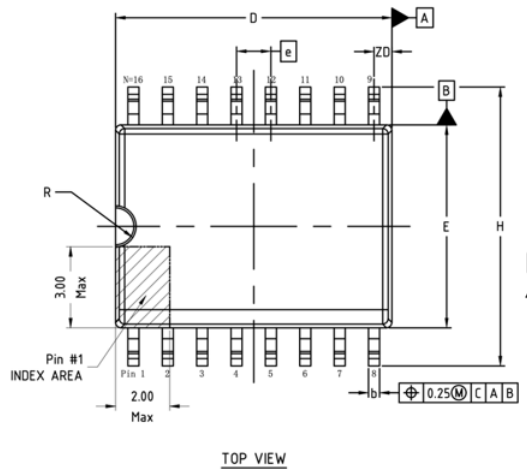

Table 1: CT432 SOICW-16 Package Dimensions

Symbol	Dimensions in Millimeters (mm)		
	Min.	Typ.	Max.
A	2.44	2.54	2.64
A1	0.10	0.20	0.30
A2	2.24	2.34	2.44
b	0.36	0.41	0.46
C	0.23	–	0.32
D	10.11	10.21	10.31
E	7.40	7.50	7.60
e	1.27 BSC		
H	10.11	10.31	10.51
h	0.31	0.51	0.71
L	0.51	0.76	1.01
L1	0.25 BSC		
R	0.76 REF		
theta 1	0.25 BSC	0.25 BSC	0.25 BSC
theta 2	0.76 REF	0.76 REF	0.76 REF
ZD	0.66 REF		
N	16		

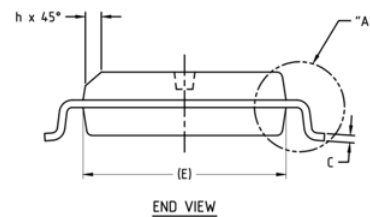
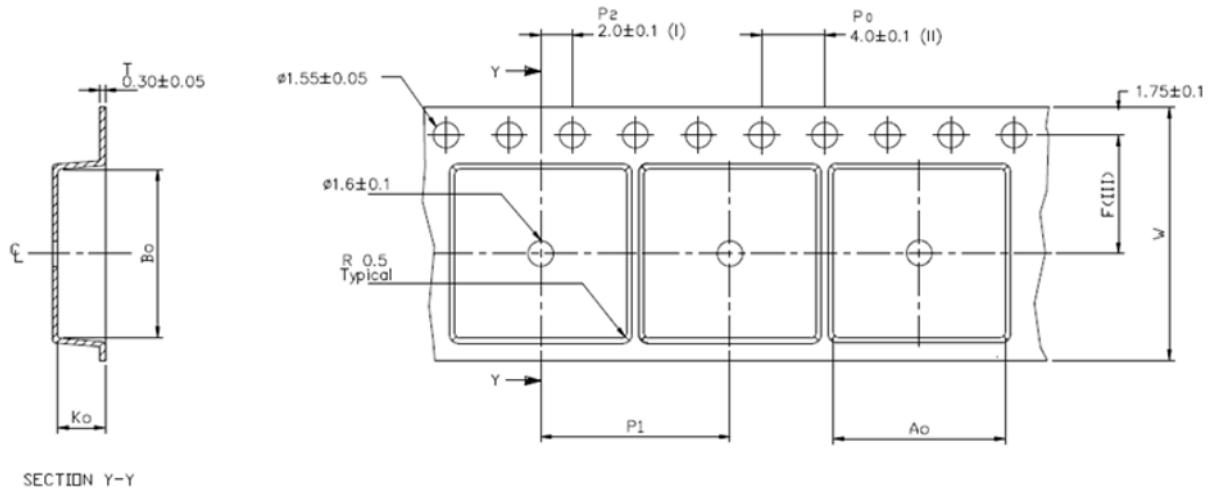

Figure 41: SOICW-16 Package Drawing and Dimensions

TAPE AND REEL POCKET DRAWING AND DIMENSIONS



Ao	10.90 +/- 0.1
Bo	10.70 +/- 0.1
Ko	3.00 +/- 0.1
F	7.50 +/- 0.1
P1	12.00 +/- 0.1
W	16.00 +/- 0.3

- (I) Measured from centreline of sprocket hole to centreline of pocket.
 - (II) Cumulative tolerance of 10 sprocket holes is ± 0.20 .
 - (III) Measured from centreline of sprocket hole to centreline of pocket.
 - (IV) Other material available.
 - (V) Typical SR of form tape Max 10⁸ OHM/SQ
- ALL DIMENSIONS IN MILLIMETRES UNLESS OTHERWISE STATED.

Figure 42: Tape and Pocket Drawing for SOICW-16 Package

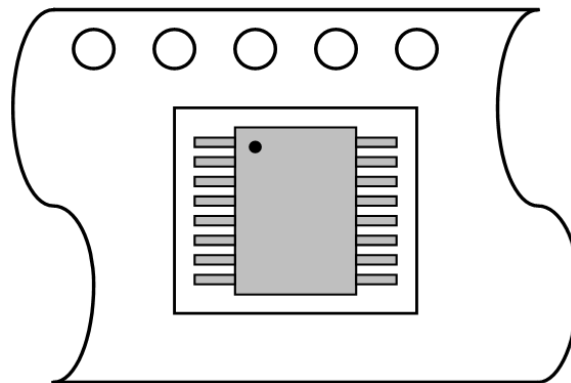

Figure 43: SOICW-16 Orientation in Tape Pocket

PACKAGE INFORMATION

Table 2: CT432 Package Information

Part Number	Package Type	# of Leads	Package Quantity	Lead Finish	MSL Rating [2]	Operating Temperature (°C) [3]	Device Marking [4]
CT432-HSWF20DR	SOICW	16	1000	Sn	3	-40 to 125	CT432 SWF20DR YYWWLL
CT432-ASWF20DR	SOICW	16	1000	Sn	3	-40 to 125	CT432A SWF20DR YYWWLL
CT432-HSWF20MR	SOICW	16	1000	Sn	3	-40 to 125	CT432 SWF20MR YYWWLL
CT432-ASWF20MR	SOICW	16	1000	Sn	3	-40 to 125	CT432A SWF20MR YYWWLL
CT432-HSWF30DR	SOICW	16	1000	Sn	3	-40 to 125	CT432 SWF30DR YYWWLL
CT432-ASWF30DR	SOICW	16	1000	Sn	3	-40 to 125	CT432A SWF30DR YYWWLL
CT432-HSWF30MR	SOICW	16	1000	Sn	3	-40 to 125	CT432 SWF30MR YYWWLL
CT432-ASWF30MR	SOICW	16	1000	Sn	3	-40 to 125	CT432A SWF30MR YYWWLL
CT432-HSWF50DR	SOICW	16	1000	Sn	3	-40 to 125	CT432 SWF50DR YYWWLL
CT432-ASWF50DR	SOICW	16	1000	Sn	3	-40 to 125	CT432A SWF50DR YYWWLL
CT432-HSWF50MR	SOICW	16	1000	Sn	3	-40 to 125	CT432 SWF50MR YYWWLL
CT432-ASWF50MR	SOICW	16	1000	Sn	3	-40 to 125	CT432A SWF50MR YYWWLL
CT432-HSWF65DR	SOICW	16	1000	Sn	3	-40 to 125	CT432 SWF65DR YYWWLL
CT432-ASWF65DR	SOICW	16	1000	Sn	3	-40 to 125	CT432A SWF65DR YYWWLL
CT432-HSWF65MR	SOICW	16	1000	Sn	3	-40 to 125	CT432 SWF65MR YYWWLL
CT432-ASWF65MR	SOICW	16	1000	Sn	3	-40 to 125	CT432A SWF65MR YYWWLL
CT432-HSWF70DR	SOICW	16	1000	Sn	3	-40 to 125	CT432A SWF70DR YYWWLL

[1] RoHS is defined as semiconductor products that are compliant to the current EU RoHS requirements. It also will meet the requirement that RoHS substances do not exceed 0.1% by weight in homogeneous materials. Green is defined as the content of chlorine (Cl), bromine (Br), and antimony trioxide based flame retardants satisfy JS709B low halogen requirements of ≤ 1,000 ppm.

[2] MSL Rating = Moisture Sensitivity Level Rating as defined by JEDEC standard classifications.

[3] Package will withstand ambient temperature range of -40°C to 125°C and storage temperature range of -65°C to 150°C.

[4] Device Marking for CT432 is defined as CT432 SWFxxZR YYWWLL where the first 2 lines = part number, YY = year, WW = work week, and LL = lot code.

DEVICE MARKING

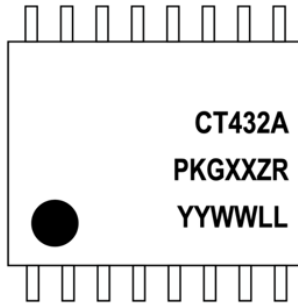
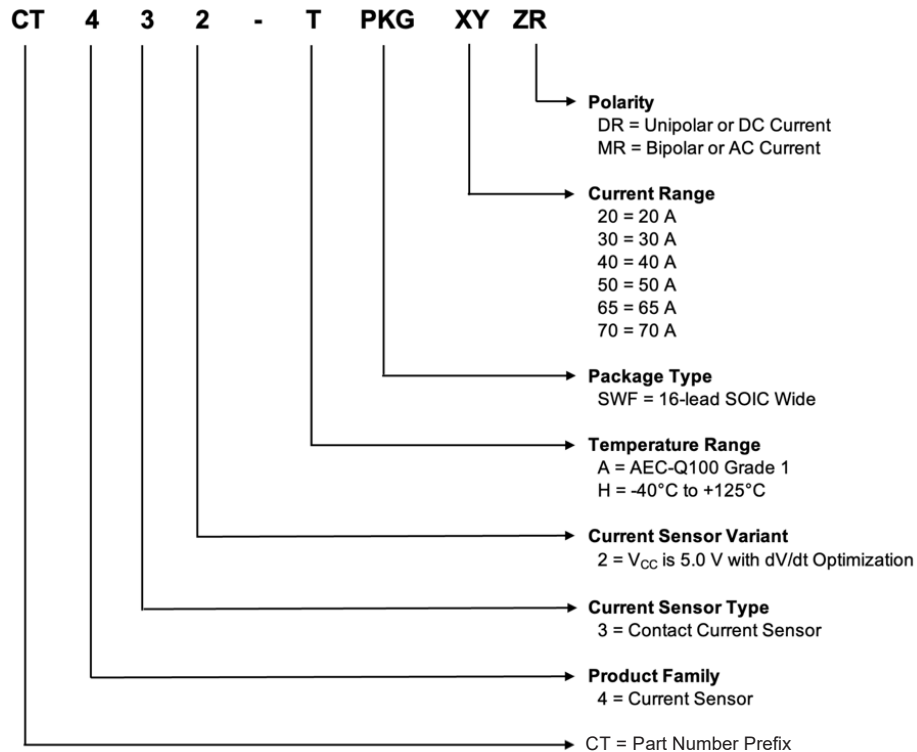

Table 3: CT432 Device Marking Definition for 16-lead SOICW Package

Row No.	Code	Definition
3	•	Pin 1 Indicator
1	CT432	Allegro Part Number
1	A	AEC-Q100 Qualified
2	PKG	Package Type
2	XX	Maximum Current Rating
2	ZR	Polarity
3	YY	Calendar Year
3	WW	Work Week
3	LL	Lot Code

Figure 44: CT432 Device Marking for 16-lead Package

PART ORDERING NUMBER LEGEND



Revision History

Number	Date	Description
2	November 2, 2023	Document rebranded and minor editorial updates

Copyright 2023, Allegro MicroSystems.

Allegro MicroSystems reserves the right to make, from time to time, such departures from the detail specifications as may be required to permit improvements in the performance, reliability, or manufacturability of its products. Before placing an order, the user is cautioned to verify that the information being relied upon is current.

Allegro's products are not to be used in any devices or systems, including but not limited to life support devices or systems, in which a failure of Allegro's product can reasonably be expected to cause bodily harm.

The information included herein is believed to be accurate and reliable. However, Allegro MicroSystems assumes no responsibility for its use; nor for any infringement of patents or other rights of third parties which may result from its use.

Copies of this document are considered uncontrolled documents.

For the latest version of this document, visit our website:

www.allegromicro.com