

CT433-50AC Evaluation Board User Guide

DESCRIPTION

The CT433 is a high bandwidth and ultralow-noise integrated contact current sensor that uses Allegro patented XtremeSense™ tunnel magnetoresistance (TMR) technology to enable high-accuracy current measurements for many industrial, consumer, and automotive applications. The device supports multiple current ranges where the integrated current-carrying conductor (CCC) handles up to 70 A of current and generates a current measurement as a linear analog output voltage. The device achieves a total output error of less than ±1% full-scale (FS) overvoltage and the full temperature range. The device has a ~300 ns output response time while the current consumption is ~6 mA and is immune to common-mode fields. The CT433 is optimized for high dV/dt applications, which minimizes capacitive coupling to VOUT, allowing the CT433 to be used in switching applications. The CT433 is offered in an industry-standard 16-lead small-outline integrated circuit (SOIC) wide package that is green and RoHS-compliant.

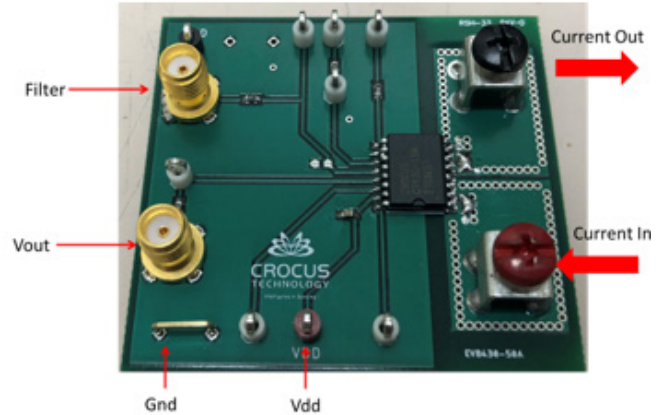

Figure 1: CT433-50AC Evaluation Board

FEATURES

- Low noise: 9.5 to 19 mA rms at $f_{BW} = 100$ kHz
- Optimized for high dV/dt applications
- Integrated current-carrying conductor
- Response time: ~300 ns
- Total error output $\leq \pm 1\%$ FS, -40°C to 125°C
- Immunity to common-mode fields: -54 dB
- Linear analog output voltage
- Supply voltage: 3 V to 3.6 V

Table of Contents

Description	1
Features	1
Evaluation Board Contents	1
Using the Evaluation Board	2
Introduction	2
Power Input	2
Board Configuration	2
Schematic	3
Layout	4
Bill of Materials	5
Related Links	6
Revision History	7

EVALUATION BOARD CONTENTS

- CT433-50AC evaluation board

Table 1: CT433-50AC Evaluation Board Configurations

Configuration Name	Part Number	Sensitivity	Bandwidth
CT433-50AC Evaluation Board	CTD433-HSWF50MR	20 mV/V	1 MHz

Table 2: General Specifications

Specification	Min	Nom	Max	Units
Input Operating Temperature	-40	-	125	°C
Input Operating Current	-50	-	50	A

USING THE EVALUATION BOARD

Introduction

This section provides an overview of the connections and configuration options of the CTD433-50AC evaluation board. The proper configuration is shown in Figure 2 and is detailed in the sections that follow. The CT433 datasheet contains detailed information about the use and functionality of each pin and detailed specifications about the sensor, and it should be consulted for more detailed information than is contained in this user guide.

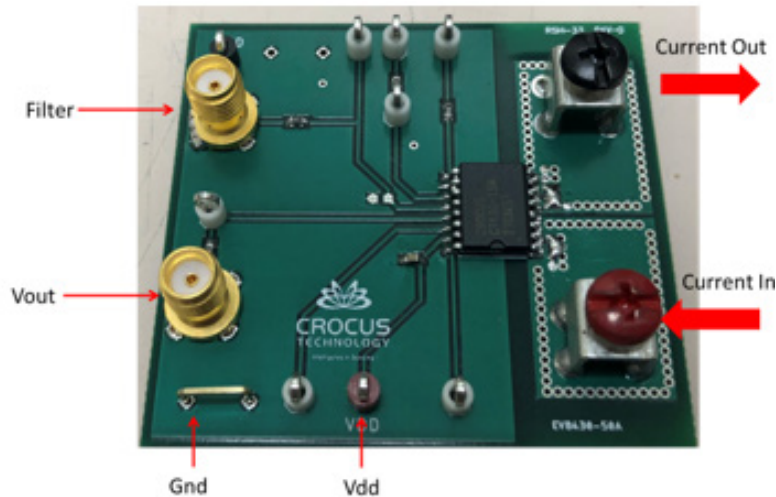

Figure 2: CT433-50AC Evaluation Board

Power Input

The two large connectors (with screws) are used to connect and drive the external current to be measured. Due to the PCB trace thermal limitation of the CT433 evaluation board, do not exceed 20 A_{PK}.

Board Configuration

A fully assembled evaluation board is illustrated in Figure 1 and Figure 2. The current to be measured is connected to the screw connectors located on the right side of the PCB. These connectors are galvanically isolated from the rest of the PCB. The CT433 can be biased by applying a 3.3 V bias voltage between the VDD and GND pins on the PCB and its output can be measured either from the VOUT SMA connector or the VOUT header pin on the PCB. In addition, if C2 is populated with a 100 pF capacitor, the FILTER SMA connector provides a filtered output of the CT433 with a 3 dB cutoff frequency of approximately 100 kHz; otherwise, the 3 dB cutoff frequency is 1 MHz. See Figure 3.

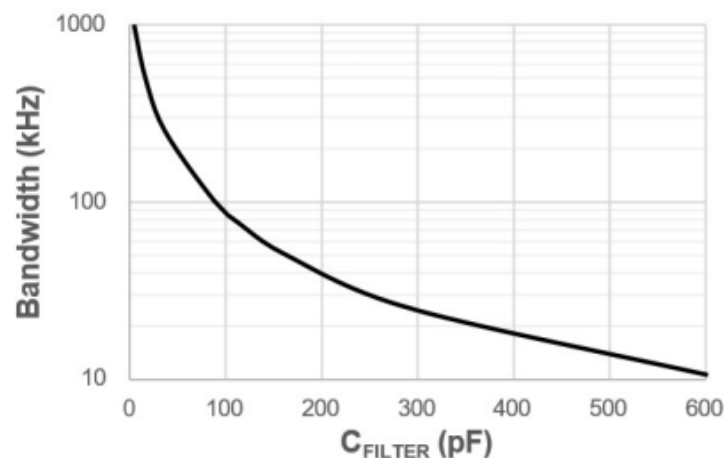

Figure 3: CT433-50AC Evaluation Board

SCHEMATIC

The schematic of the CT433-50AC evaluation board is shown in Figure 4.

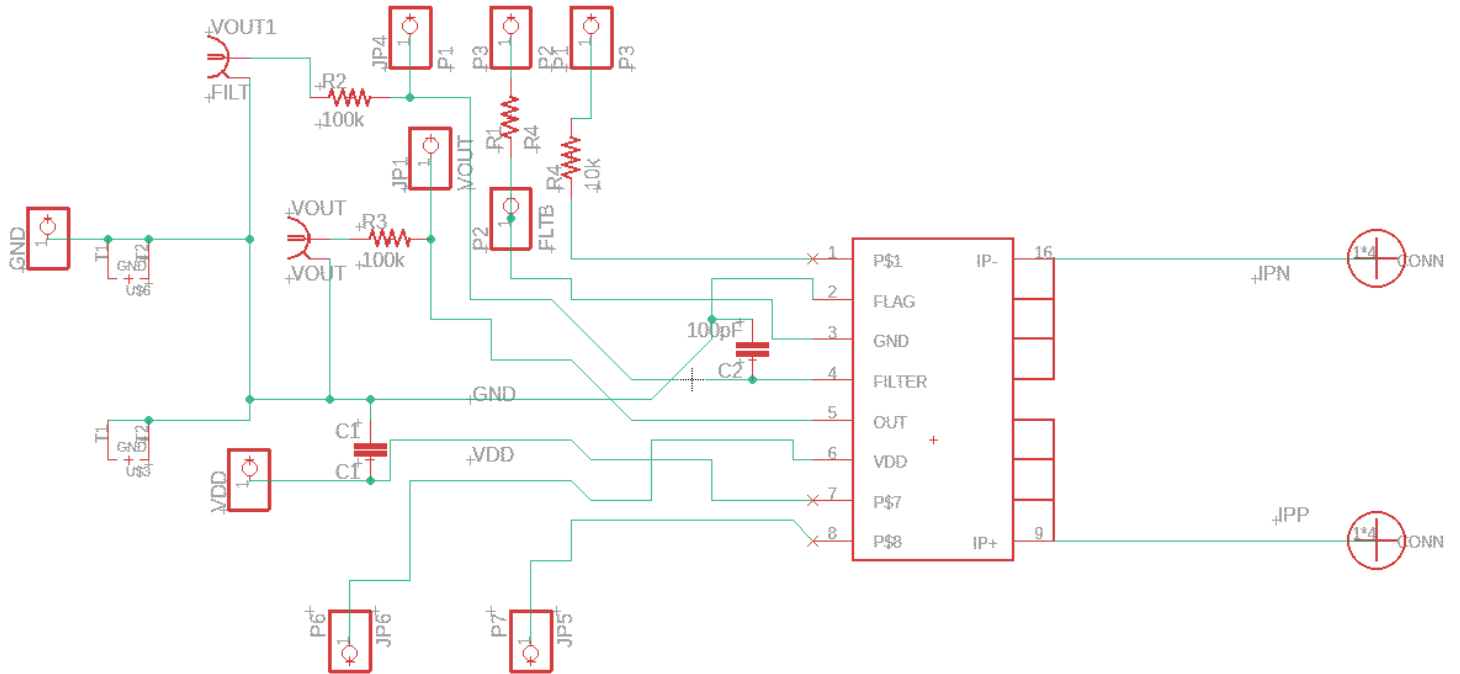

Figure 4: CT433-50AC Evaluation Board Schematic

LAYOUT

The top and bottom layers of the CT433-50AC evaluation board are shown in Figure 5 and Figure 6, respectively.

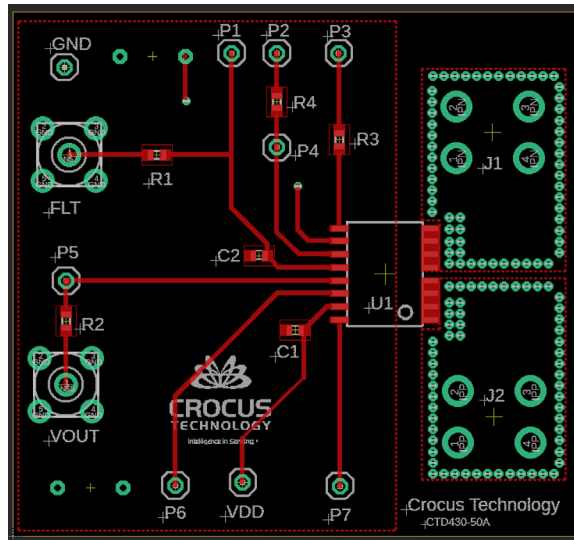

Figure 5: Top Layer

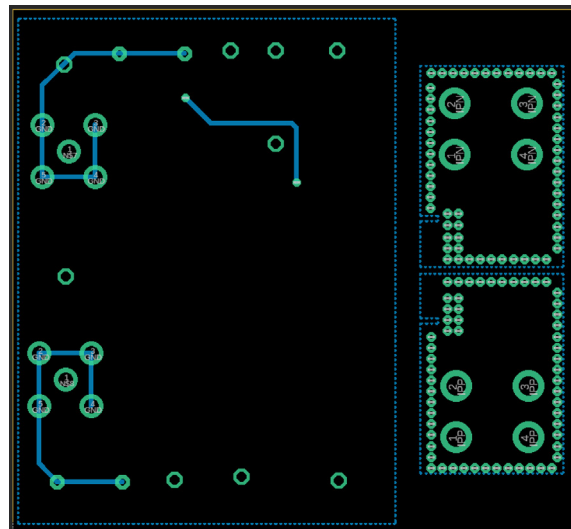

Figure 6: Bottom Layer

BILL OF MATERIALS

Designator	Quantity	Description	Manufacturer	Manufacturer Part Number
PCB	1	CT433-50AC evaluation board	Allegro MicroSystems	–
U1	1	CT433-HSWF50MR sensor	Allegro MicroSystems	–
C1	1	1.0 μ F, X5R or better SMD Capacitor 0603	TDK	CGA3E1X7R1E105K080AC
C2	1	100 pF, X5R or better SMD Capacitor 0603 (optional)	KEMET	C0603C101K4HACAUTO
R1, R2, R3	3	10 k Ω , \pm 10% or better SMD Resistor 0603	Panasonic	ERJ-3GEYJ103V
R4	1	100 k Ω , \pm 10% or better SMD Resistor 0603	Yageo	RC0603FR-07100KL
VOUT, FLT	2	SMA Connectors	Clinch Connectivity	142-0701-201
J1, J2	2	Screw Connectors	Keystone	534-7701
J2	1	M3 Terminal Screw Red	Keystone	36-7701-2
J1	1	M3 Terminal Screw Black	Keystone	36-7701-3
P1–7, GND, VDD	9	Male Header Connectors - Single pin	Würth Elektronik	732-5334-ND

RELATED LINKS

CT433 product page:

<https://www.allegromicro.com/en/products/sense/current-sensor-ics/zero-to-fifty-amp-integrated-conductor-sensor-ics/CT433>

For samples or applications support contact, visit <https://www.allegromicro.com/en/about-allegro/contact-us/technical-assistance> and navigate to the appropriate region.

Revision History

Number	Date	Description
-	August 7, 2024	Initial release

Copyright 2024, Allegro MicroSystems.

Allegro MicroSystems reserves the right to make, from time to time, such departures from the detail specifications as may be required to permit improvements in the performance, reliability, or manufacturability of its products. Before placing an order, the user is cautioned to verify that the information being relied upon is current.

Allegro's products are not to be used in any devices or systems, including but not limited to life support devices or systems, in which a failure of Allegro's product can reasonably be expected to cause bodily harm.

The information included herein is believed to be accurate and reliable. However, Allegro MicroSystems assumes no responsibility for its use; nor for any infringement of patents or other rights of third parties which may result from its use.

Copies of this document are considered uncontrolled documents.